

## Standardised "EN 733" centrifugal pumps

 Clean water

 Industrial use



### PERFORMANCE RANGE

- Flow rate up to **5500 l/min** (330 m<sup>3</sup>/h)
- Head up to **98 m**

### APPLICATION LIMITS

- Manometric suction lift up to **7 m**
- Liquid temperature between **-10 °C** and **+90 °C**
- Ambient temperature between **-10 °C** and **+55 °C**
- Max. pressure in pump body **10 bar** (PN10)
- Continuous service **S1**

### CONSTRUCTION AND SAFETY STANDARDS

EN 60335-1  
IEC 60335-1  
CEI 61-150

EN 60034-1  
IEC 60034-1  
CEI 2-3



Pump body dimensions in compliance with **EN 733**

### CERTIFICATIONS

Company with management system certified DNV  
ISO 9001: QUALITY

### INSTALLATION AND USE

- Water supply
- Pressure boosting
- Irrigation
- Water circulation in air-conditioning units
- Cleaning sets
- Firefighting sets
- Industrial applications
- Agricultural applications

The pump should be installed in an enclosed environment or sheltered from inclement weather.

### OPTIONS AVAILABLE ON REQUEST

- Counter flange KIT complete with bolts, nuts and washers
- Special mechanical seal
- Other voltages
- Compatibility with hotter or colder liquids
- Compatibility with hotter or colder environments

### GUARANTEE

2 years subject to terms and conditions

## PERFORMANCE RANGE

60 Hz n= 3450 min<sup>-1</sup>

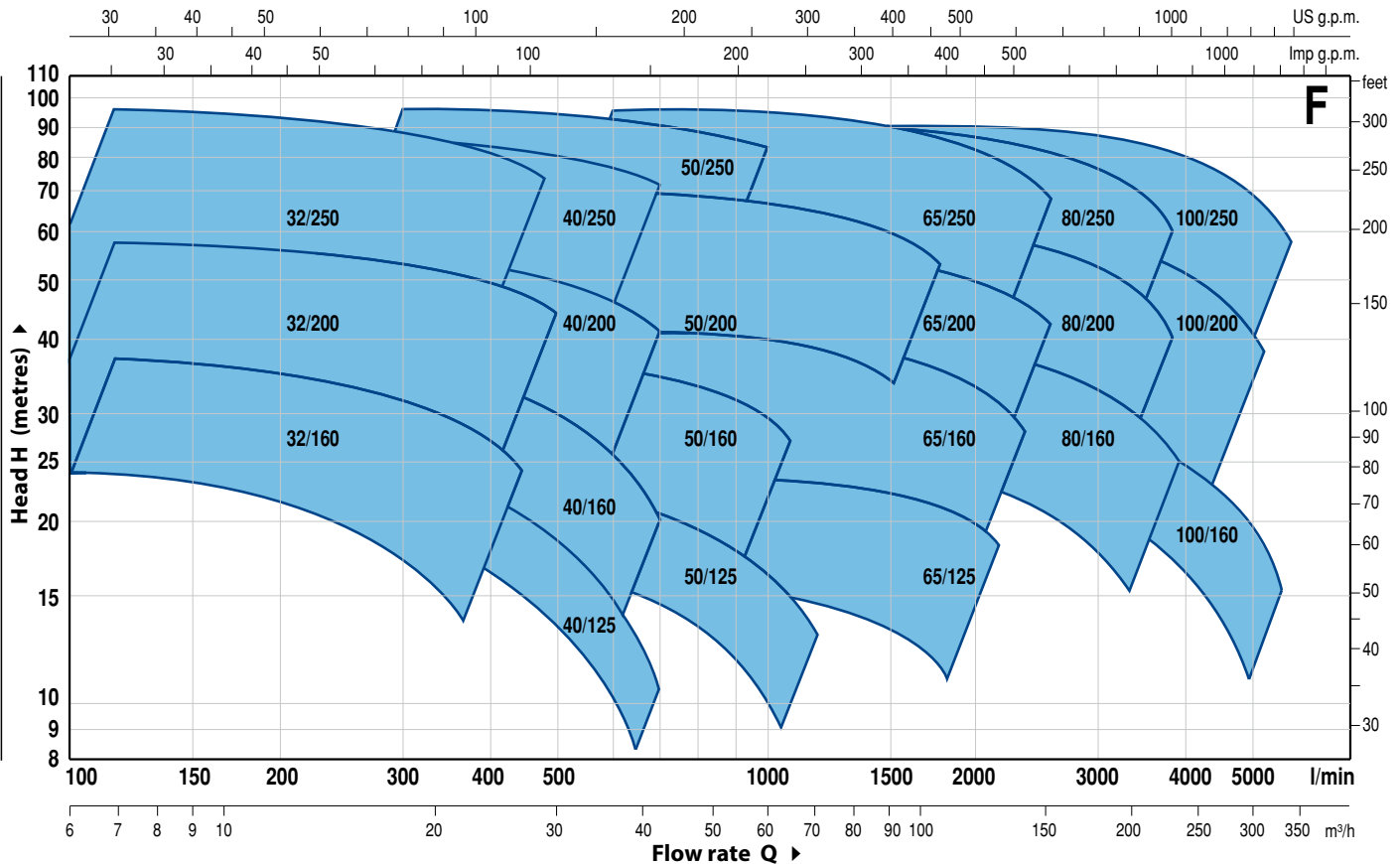

## PERFORMANCE DATA

60 Hz n= 3450 min<sup>-1</sup>

MODEL	POWER (P <sub>2</sub> )		▲	PERFORMANCE	
	kW	HP		Q l/min	H metres
<b>Three-phase</b>					
F 32/160C	1.5	2	IE3	100 ÷ 350	24 ÷ 14
F 32/160B	2.2	3		100 ÷ 400	30 ÷ 17
F 32/160A	3	4		100 ÷ 450	37 ÷ 24
F 32/200C	4	5.5	IE3	100 ÷ 450	44 ÷ 31.5
F 32/200B	5.5	7.5		100 ÷ 500	51 ÷ 36
F 32/200A	7.5	10		100 ÷ 500	57 ÷ 44
F 32/200BH	3	4	IE3	100 ÷ 300	45 ÷ 37
F 32/200AH	4	5.5		100 ÷ 320	55 ÷ 44
F 32/250C	9.2	12.5		100 ÷ 450	75 ÷ 60
F 32/250B	11	15	IE3	100 ÷ 500	87 ÷ 70
F 32/250A	15	20		100 ÷ 500	97 ÷ 80
F 40/125C	1.1	1.5		100 ÷ 550	16 ÷ 6
F 40/125B	1.5	2	IE3	100 ÷ 600	20.5 ÷ 9
F 40/125A	2.2	3		100 ÷ 700	26 ÷ 10
F 40/160C	2.2	3		100 ÷ 600	27 ÷ 14
F 40/160B	3	4	IE3	100 ÷ 600	32 ÷ 20
F 40/160A	4	5.5		100 ÷ 700	38 ÷ 20
F 40/200B	5.5	7.5		100 ÷ 700	47 ÷ 28
F 40/200A	7.5	10	IE3	100 ÷ 700	55 ÷ 41
F 40/250C	9.2	12.5		100 ÷ 700	64 ÷ 47
F 40/250B	11	15		100 ÷ 700	71 ÷ 55
F 40/250A	15	20	IE3	100 ÷ 700	88 ÷ 72
F 50/125C	2.2	3		300 ÷ 1200	17.5 ÷ 6
F 50/125B	3	4		IE3	300 ÷ 1200
F 50/125A	4	5.5	300 ÷ 1200		23.5 ÷ 13
F 50/160C	4	5.5	300 ÷ 1000		27 ÷ 16
F 50/160B	5.5	7.5	IE3	300 ÷ 1100	32 ÷ 21
F 50/160A	7.5	10		300 ÷ 1100	37 ÷ 27
F 50/200C	11	15		400 ÷ 1700	44 ÷ 30
F 50/200B	15	20	IE3	400 ÷ 1700	52 ÷ 38
F 50/200A	18.5	25		400 ÷ 1800	61 ÷ 45
F 50/200AR	22	30		400 ÷ 1800	69 ÷ 53
F 50/250D	9.2	12.5	IE3	300 ÷ 900	51 ÷ 32
F 50/250C	11	15		300 ÷ 900	59 ÷ 42
F 50/250B	15	20		300 ÷ 1000	72 ÷ 59
F 50/250A	18.5	25	IE3	300 ÷ 1000	85 ÷ 73
F 50/250AR	22	30		300 ÷ 1000	95 ÷ 83

MODEL	POWER (P <sub>2</sub> )		▲	PERFORMANCE	
	kW	HP		Q l/min	H metres
<b>Three-phase</b>					
F 65/125C	4	5.5	IE3	600 ÷ 1800	16 ÷ 11
F 65/125B	5.5	7.5		600 ÷ 2000	18 ÷ 13
F 65/125A	7.5	10		600 ÷ 2200	23 ÷ 18
F 65/160C	9.2	12.5	IE3	600 ÷ 2200	32 ÷ 22
F 65/160B	11	15		600 ÷ 2400	36.5 ÷ 23
F 65/160A	15	20		600 ÷ 2400	40.5 ÷ 28
F 65/200B	15	20	IE3	200 ÷ 2400	44 ÷ 30.5
F 65/200A	18.5	25		200 ÷ 2500	50 ÷ 36.5
F 65/200AR	22	30		200 ÷ 2600	57 ÷ 42
F 65/250C	30	40	IE3	400 ÷ 2350	76 ÷ 53
F 65/250B	37	50		400 ÷ 2500	87 ÷ 62
F 65/250A	45	60		400 ÷ 2600	95 ÷ 68
F 80/160D	11	15	IE3	500 ÷ 4000	25 ÷ 10
F 80/160C	15	20		500 ÷ 4000	30 ÷ 15
F 80/160B	18.5	25		500 ÷ 4000	35 ÷ 20
F 80/160A	22	30	IE3	500 ÷ 4000	40 ÷ 25
F 80/200B	30	40		500 ÷ 3650	56 ÷ 34.5
F 80/200A	37	50		500 ÷ 3900	62 ÷ 40
F 80/250B	45	60	IE3	600 ÷ 3600	77 ÷ 54
F 80/250A	55	75		600 ÷ 3900	88.5 ÷ 60
F 100/160A-N	22	30		1000 ÷ 5500	40 ÷ 16.5
F 100/200C	30	40	IE3	833 ÷ 4650	51 ÷ 28
F 100/200B	37	50		833 ÷ 4900	57 ÷ 33
F 100/200A	45	60		833 ÷ 5250	63 ÷ 38
F 100/250B	55	75	IE3	800 ÷ 5150	75 ÷ 48
F 100/250A	75	100		800 ÷ 5750	89 ÷ 58

Q = Flow rate

H = Total manometric head

Tolerance of characteristic curves in compliance with EN ISO 9906 Grade 3B.

▲ Performance class of the three-phase motor (IEC-60034-30)

# F32/160

## CHARACTERISTIC CURVES AND PERFORMANCE DATA

60 Hz n = 3450 min<sup>-1</sup> HS = 0 m

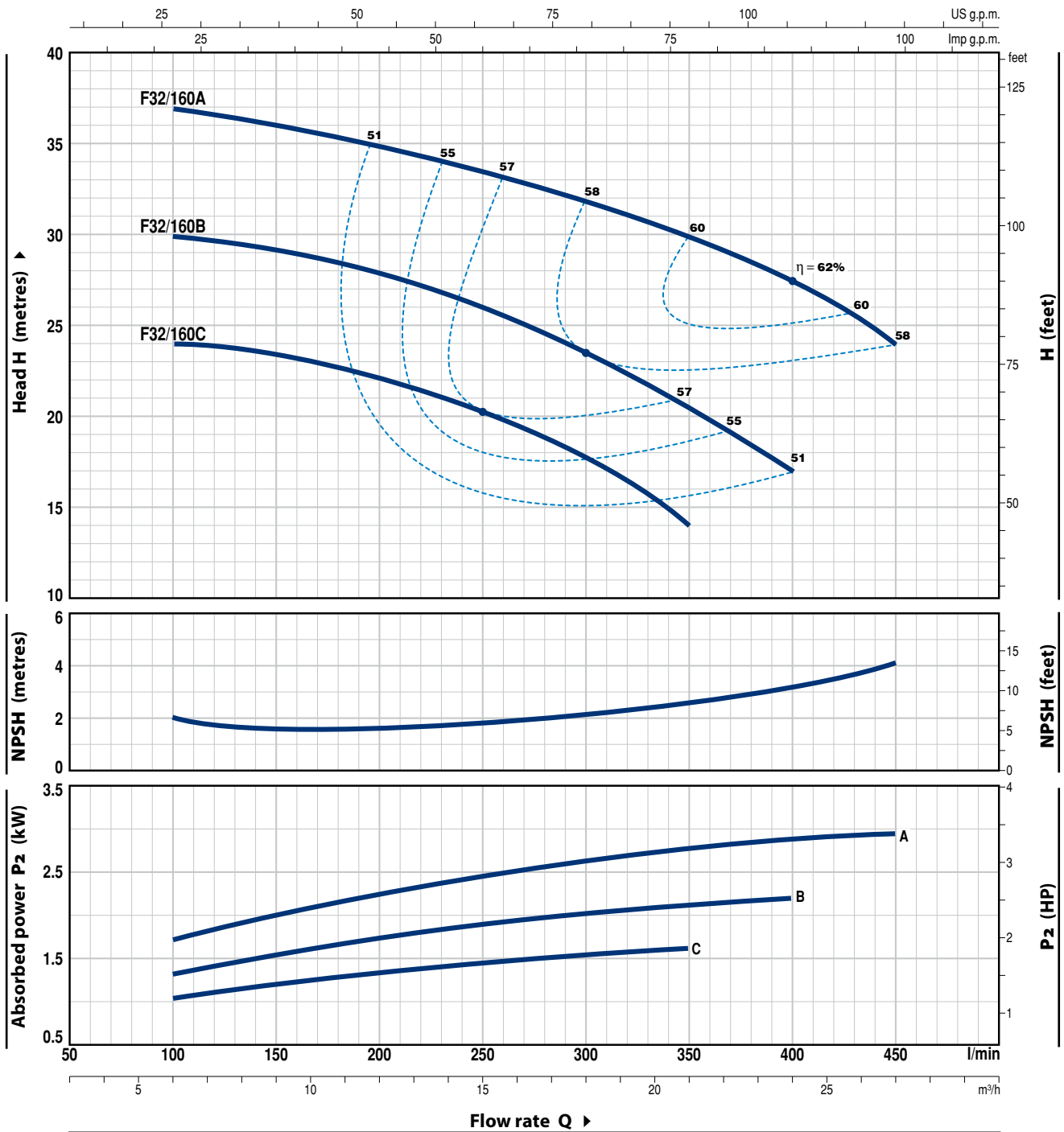

MODEL		POWER (P <sub>2</sub> )		Q	Flow rate												
Single-phase	Three-phase	kW	HP		m <sup>3</sup> /h	0	6	9	12	15	18	21	24	27			
Fm 32/160C	F 32/160C	1.5	2	l/min	0	100	150	200	250	300	350	400	450				
	Fm 32/160B	F 32/160B	2.2	3	H metres	31	30	29	28	26	23.5	20.5	17				
-	F 32/160A	3	4		38	37	36	35	33.5	31.5	30	27.5	24				

Q = Flow rate H = Total manometric head HS = Suction height

Tolerance of characteristic curves in compliance with EN ISO 9906 Grade 3B.

## CHARACTERISTIC CURVES AND PERFORMANCE DATA

60 Hz n = 3450 min<sup>-1</sup> HS = 0 m

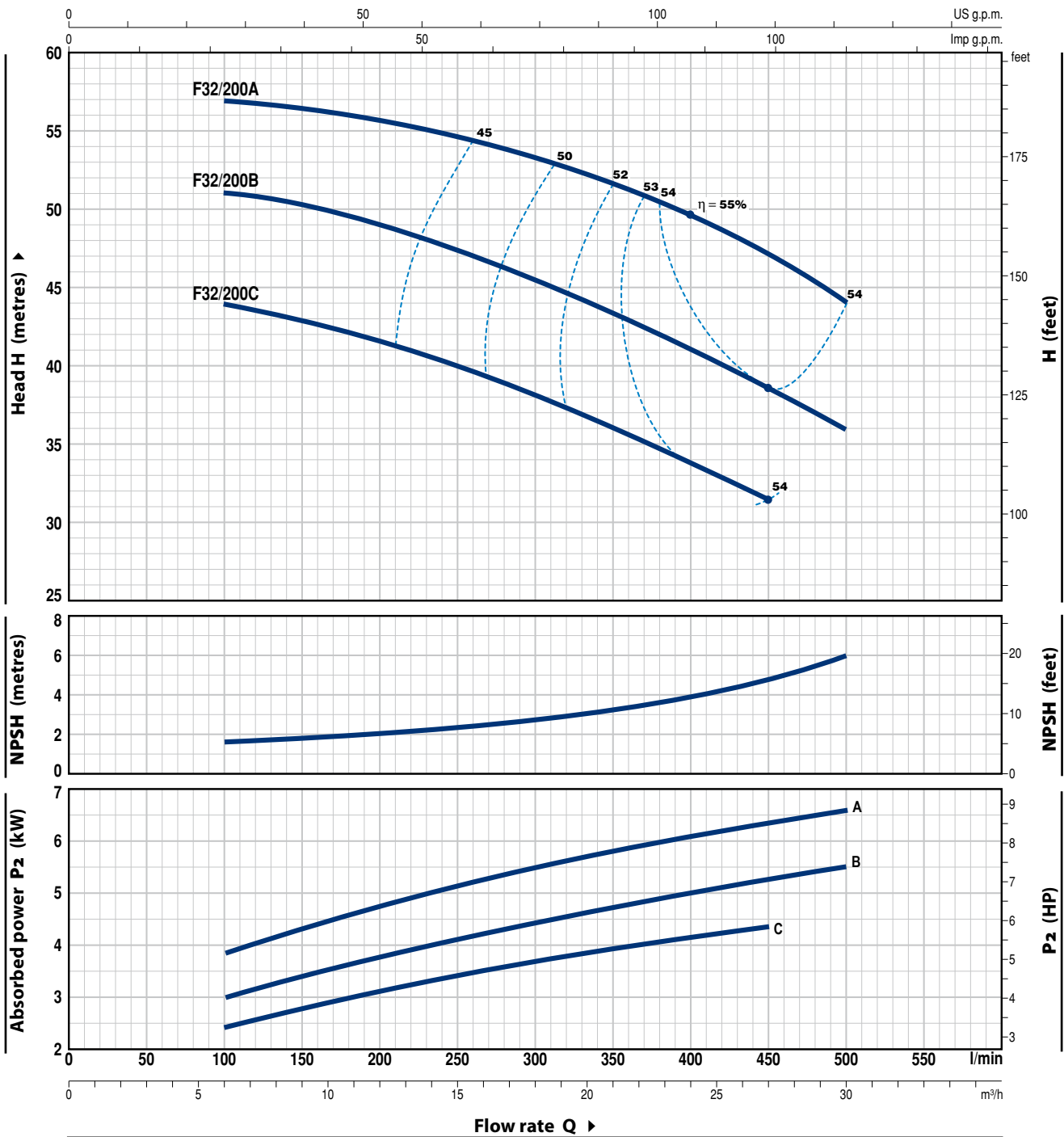

MODEL	POWER (P <sub>2</sub> )		Q	Flow rate												
	kW	HP		0	6	9	12	15	18	21	24	27	30			
Three-phase			l/min	0	100	150	200	250	300	350	400	450	500			
F 32/200C	4	5.5	H metres	46	44	43	41.5	40	38	36	34	31.5				
F 32/200B	5.5	7.5		52	51	50.5	49	47	45	43	41	38.5	36			
F 32/200A	7.5	10		60	57	56.5	56	55	53.5	52	50	47	44			

Q = Flow rate H = Total manometric head HS = Suction height

Tolerance of characteristic curves in compliance with EN ISO 9906 Grade 3B.

# F32/200H

## CHARACTERISTIC CURVES AND PERFORMANCE DATA

60 Hz n = 3450 min<sup>-1</sup> HS = 0 m

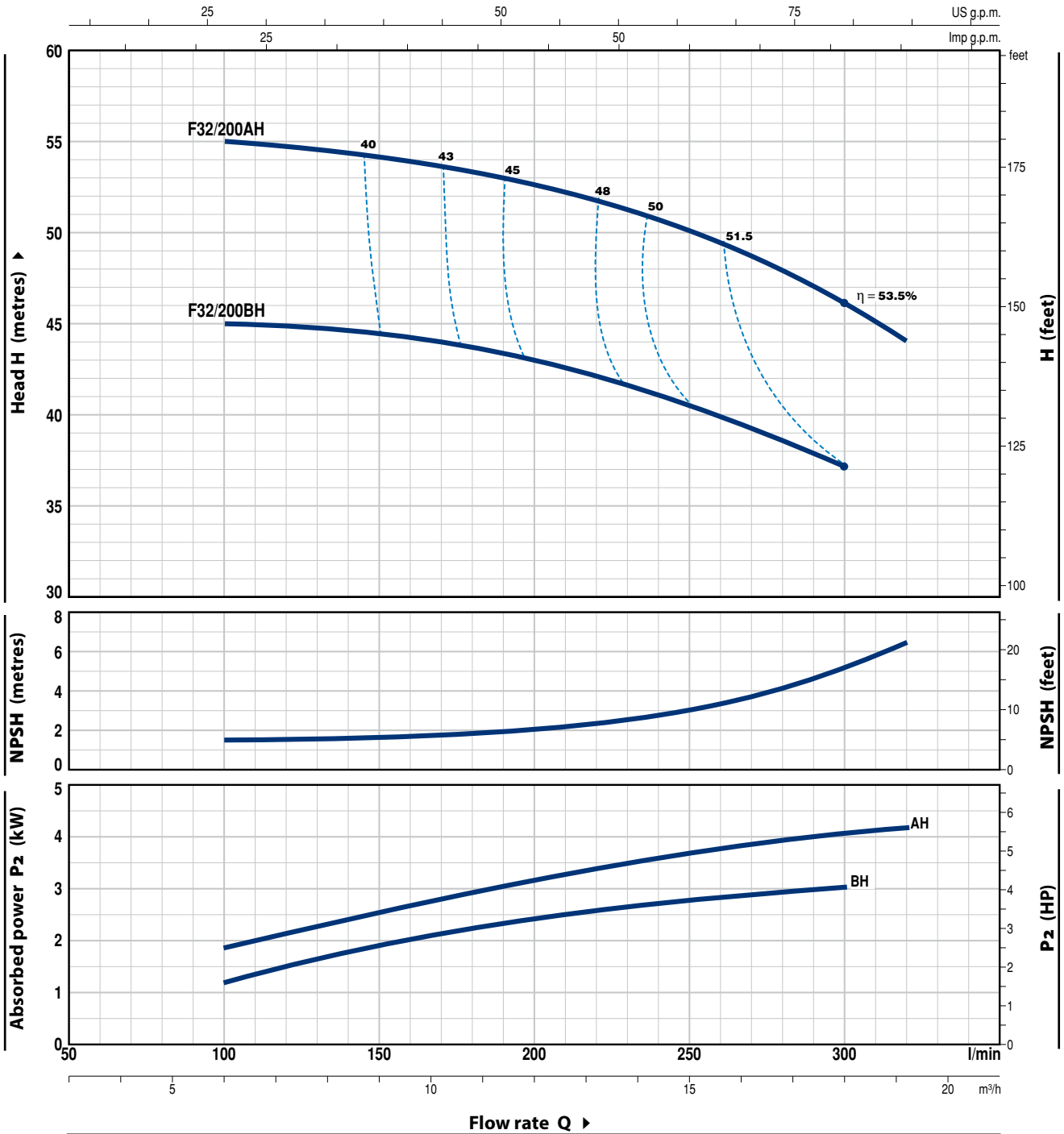

MODEL	POWER (P <sub>2</sub> )		Q	Flow rate Q						
	kW	HP		0	6	9	12	15	18	19.2
Three-phase				0	100	150	200	250	300	320
F 32/200BH	3	4	H metres	47	45	44.5	43	40.5	37	
F 32/200AH	4	5.5		57	55	54	52.5	50	46	44

Q = Flow rate H = Total manometric head HS = Suction height

Tolerance of characteristic curves in compliance with EN ISO 9906 Grade 3B.

## CHARACTERISTIC CURVES AND PERFORMANCE DATA

60 Hz n = 3450 min<sup>-1</sup> HS = 0 m

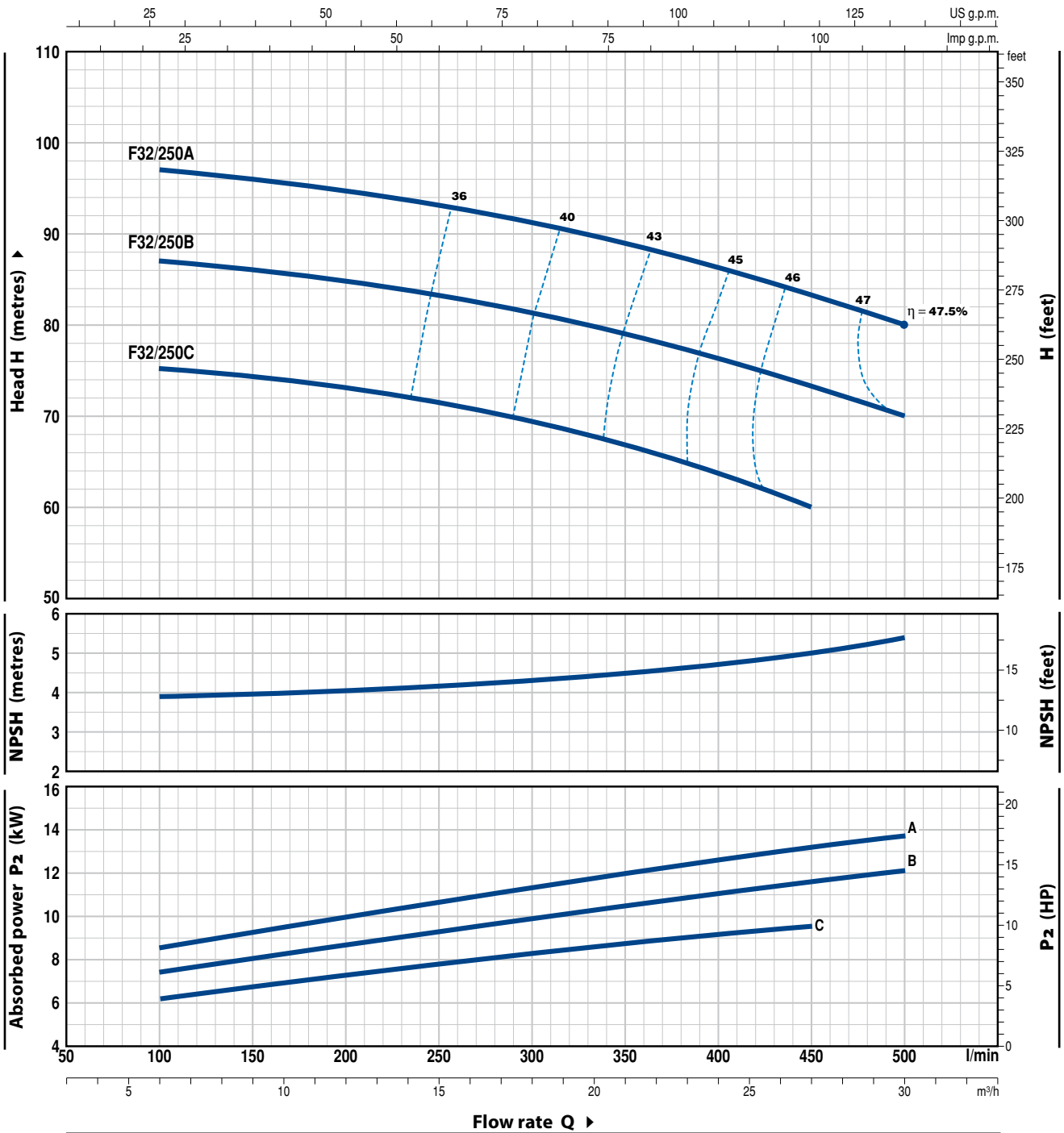

MODEL	POWER (P <sub>2</sub> )		Q	Flow rate											
	kW	HP		0	6	9	12	15	18	21	24	27	30		
Three-phase			$\frac{m^3}{h}$	0	6	9	12	15	18	21	24	27	30		
			l/min	0	100	150	200	250	300	350	400	450	500		
F 32/250C	9.2	12.5	H metres	76	75	74.5	73	71.5	69.5	67	64	60			
F 32/250B	11	15		88	87	86	85	83	81	79	76.5	73.5	70		
F 32/250A	15	20		98	97	96	95	93	91	89	86.5	83.5	80		

Q = Flow rate H = Total manometric head HS = Suction height

Tolerance of characteristic curves in compliance with EN ISO 9906 Grade 3B.

# F40/125

## CHARACTERISTIC CURVES AND PERFORMANCE DATA

60 Hz n = 3450 min<sup>-1</sup> HS = 0 m

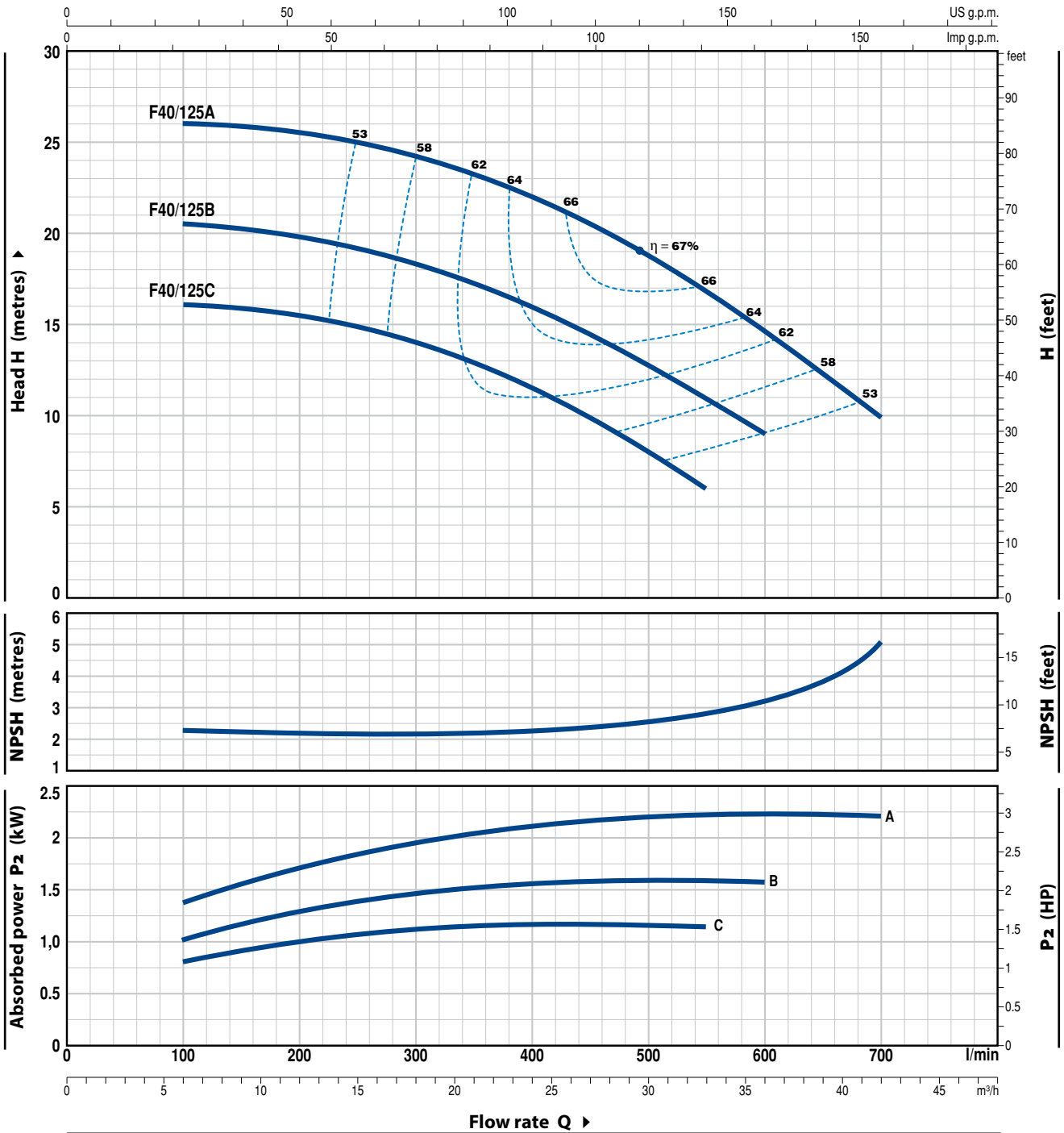

MODEL		POWER (P <sub>2</sub> )		Q	Flow rate													
Single-phase	Three-phase	kW	HP		m <sup>3</sup> /h	0	6	12	18	24	30	33	36	39	42			
Fm 40/125C	F 40/125C	1.1	1.5	l/min	0	100	200	300	400	500	550	600	650	700				
				H metres	16	16	15.5	14	11.5	8	6							
					20.5	20.5	19.8	18.5	16	12.8	11	9						
					26	26	25.5	24	22	18.5	17	14.5	12.5	10				

Q = Flow rate H = Total manometric head HS = Suction height

Tolerance of characteristic curves in compliance with EN ISO 9906 Grade 3B.

## CHARACTERISTIC CURVES AND PERFORMANCE DATA

60 Hz n = 3450 min<sup>-1</sup> HS = 0 m

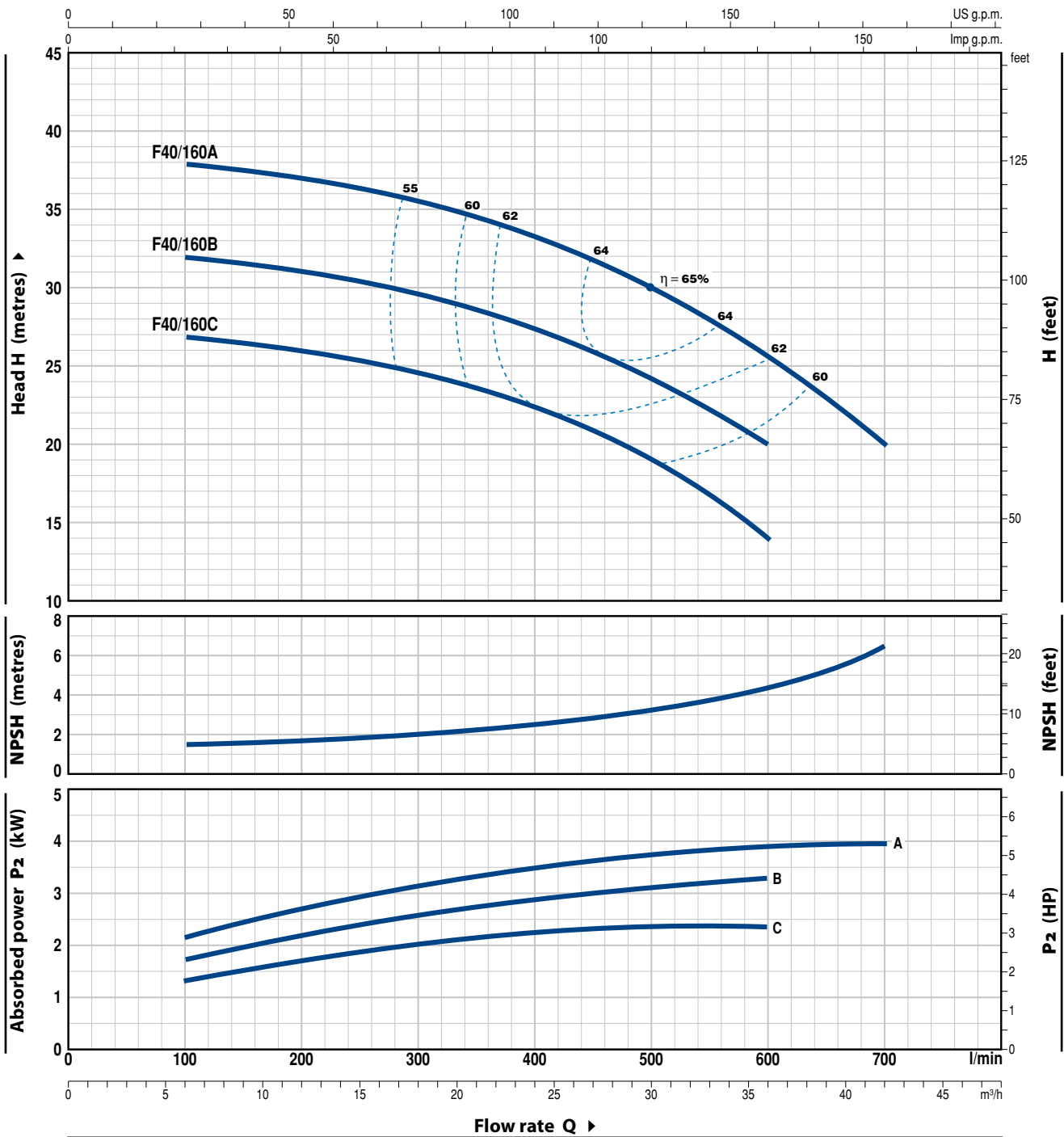

MODEL		POWER (P <sub>2</sub> )		Q	Flow rate												
Single-phase	Three-phase	kW	HP		m <sup>3</sup> /h	0	6	9	12	15	18	24	30	36	42		
				l/min	0	100	150	200	250	300	400	500	600	700			
Fm 40/160C	F 40/160C	2.2	3	H metres	27	27	26.5	26	25.5	25	22.5	19	14				
-	F 40/160B	3	4		32	32	31.5	31	30.5	30	27.5	24	20				
-	F 40/160A	4	5.5		38	38	37.8	37	36.5	36	33.5	30	26	20			

Q = Flow rate H = Total manometric head HS = Suction height

Tolerance of characteristic curves in compliance with EN ISO 9906 Grade 3B.



# F40/200

## CHARACTERISTIC CURVES AND PERFORMANCE DATA

60 Hz n = 3450 min<sup>-1</sup> HS = 0 m

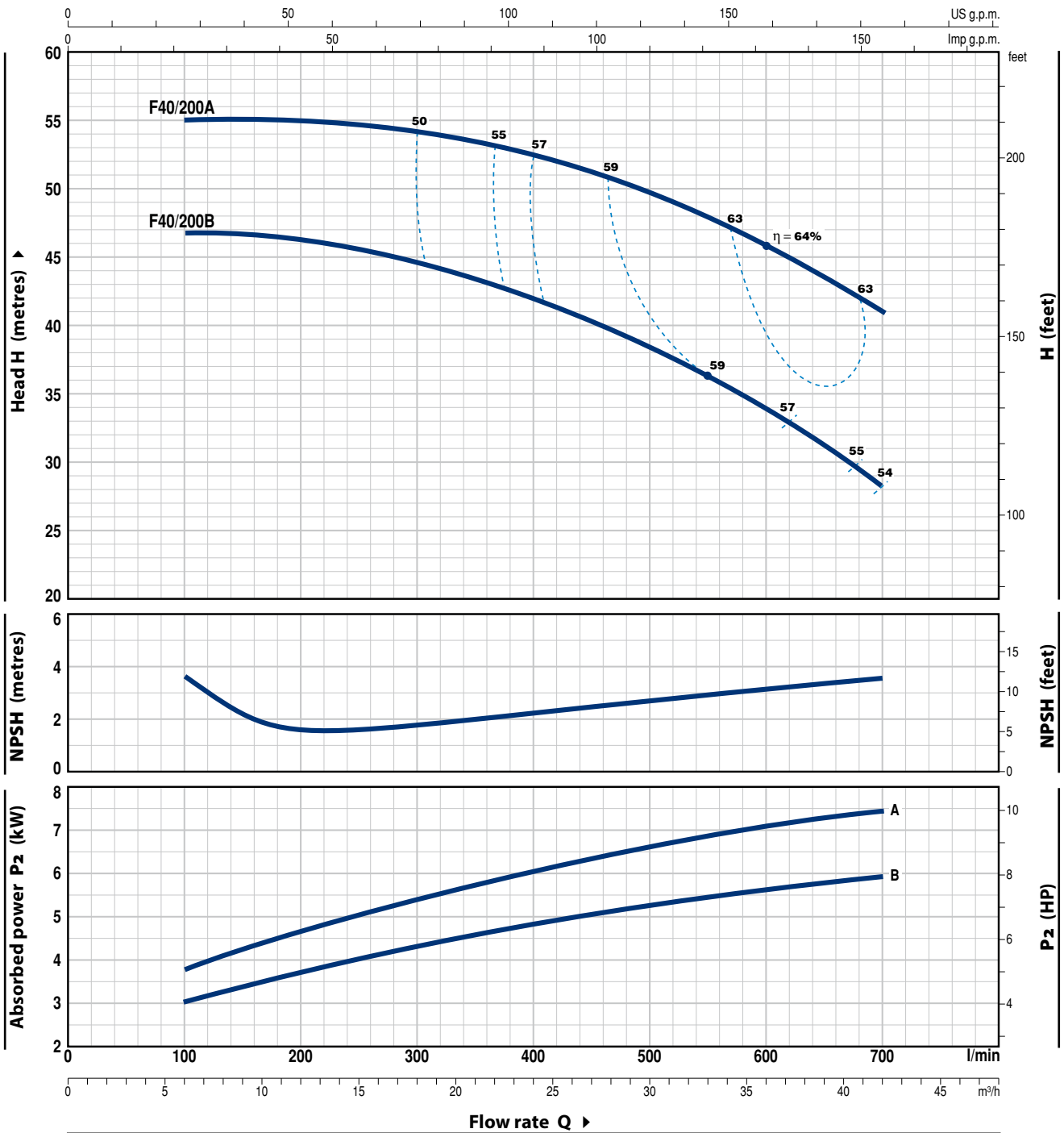

MODEL	POWER (P <sub>2</sub> )		Q	Flow rate											
	kW	HP		0	6	9	12	15	18	24	30	36	42		
Three-phase			l/min	0	100	150	200	250	300	400	500	600	700		
F 40/200B	5.5	7.5	H metres	48	47	46.5	46	45.5	44.5	42	38	34	28		
F 40/200A	7.5	10		56	55	55	55	54.5	54	52.5	49.5	46	41		

Q = Flow rate H = Total manometric head HS = Suction height

Tolerance of characteristic curves in compliance with EN ISO 9906 Grade 3B.

## CHARACTERISTIC CURVES AND PERFORMANCE DATA

60 Hz n = 3450 min<sup>-1</sup> HS = 0 m

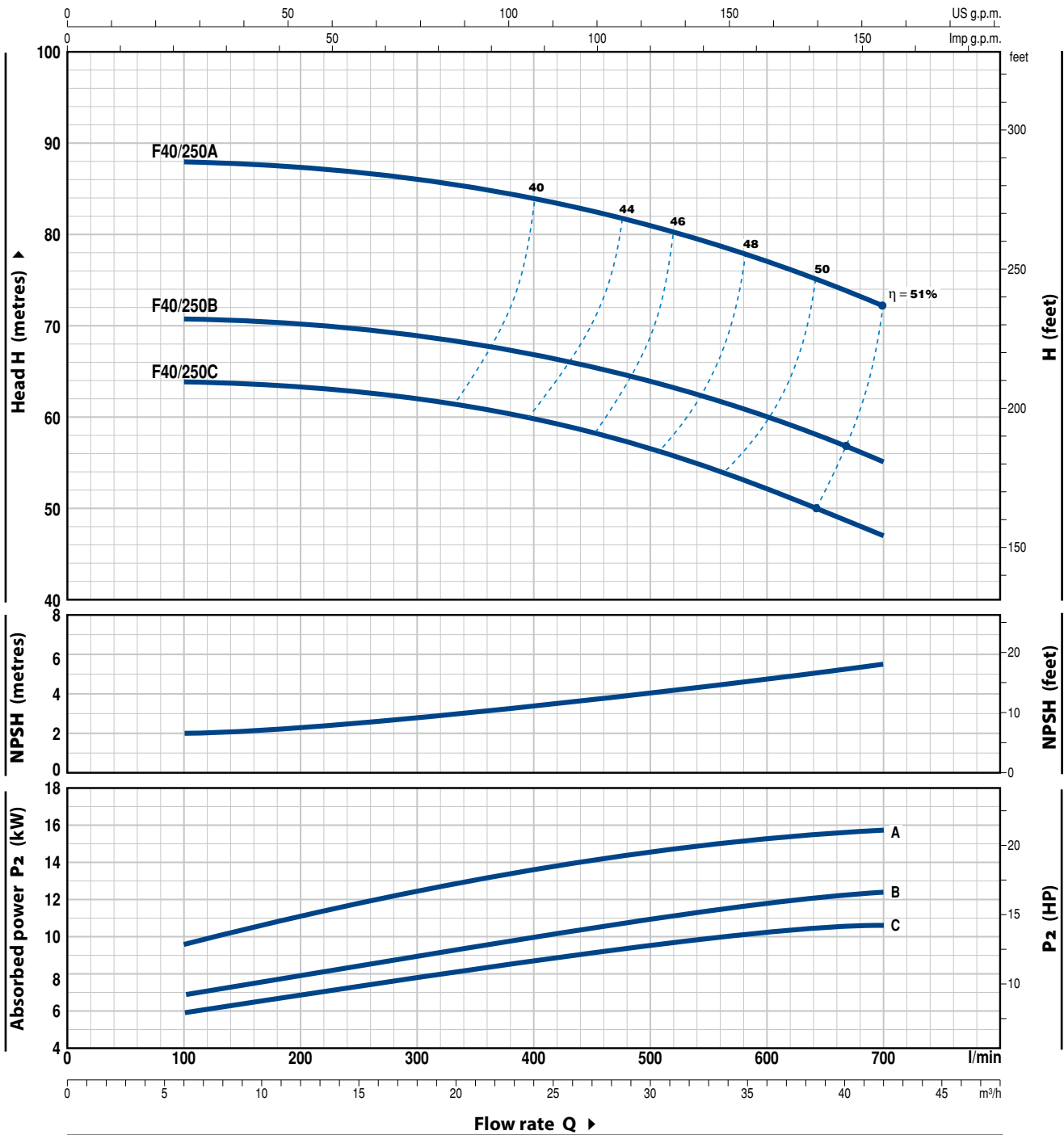

MODEL	POWER (P <sub>2</sub> )		Q	Flow rate											
	kW	HP		0	6	9	12	15	18	24	30	36	42		
Three-phase			l/min	0	100	150	200	250	300	400	500	600	700		
F 40/250C	9.2	12.5	H metres	64	64	63.5	63	62.5	62	60	56.5	52.5	47		
F 40/250B	11	15		71	71	70.5	70	69.5	69	67	64	60	55		
F 40/250A	15	20		88	88	87.5	87	86.5	86	84	81	77	72		

Q = Flow rate H = Total manometric head HS = Suction height

Tolerance of characteristic curves in compliance with EN ISO 9906 Grade 3B.

# F50/125

## CHARACTERISTIC CURVES AND PERFORMANCE DATA

60 Hz n = 3450 min<sup>-1</sup> HS = 0 m

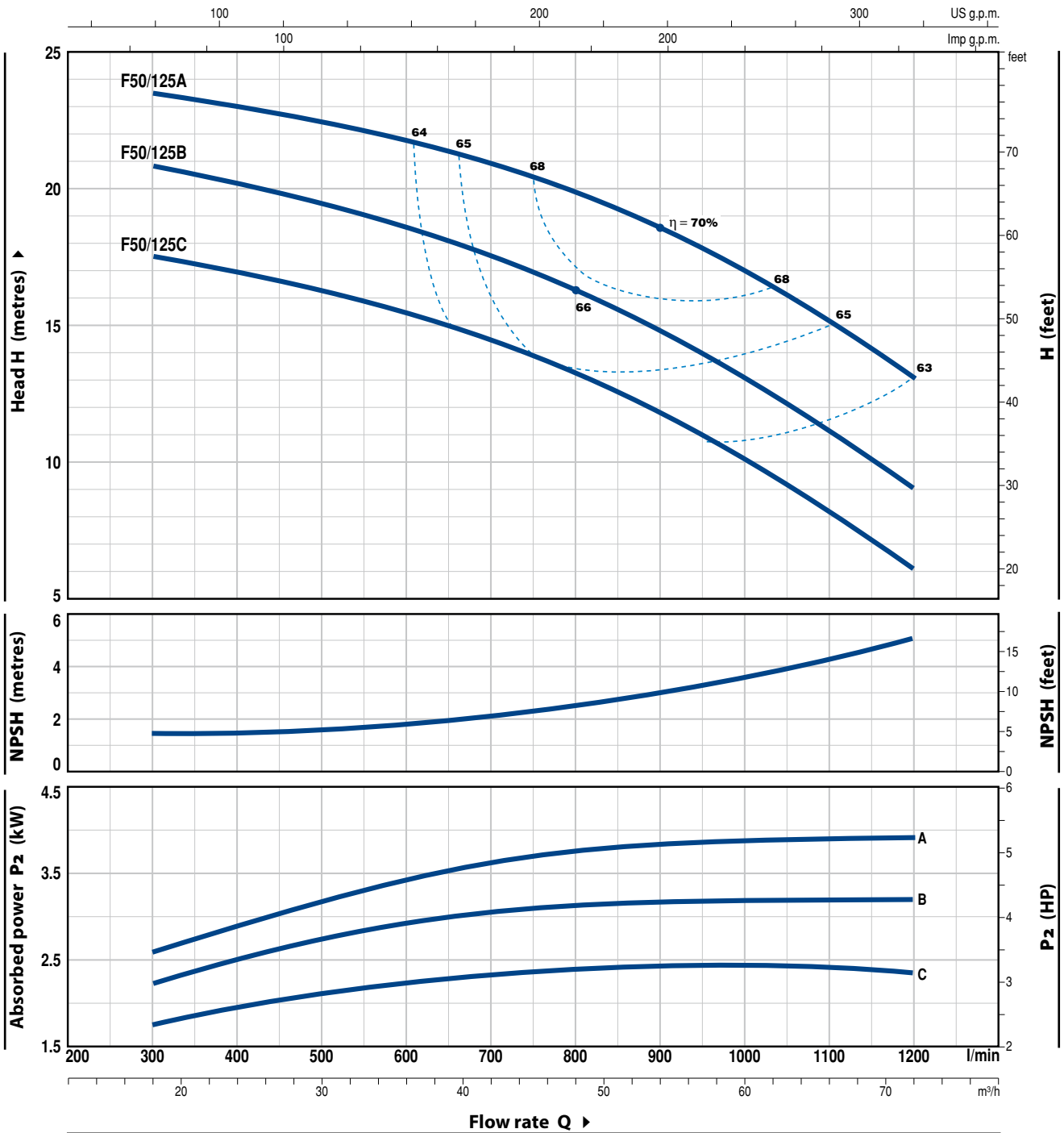

MODEL		POWER (P <sub>2</sub> )		Q	H metres												
Single-phase	Three-phase	kW	HP		0	18	24	30	36	42	48	54	60	66	72		
				l/min	0	300	400	500	600	700	800	900	1000	1100	1200		
Fm 50/125C	F 50/125C	2.2	3		18.5	17.5	17	16.5	15.5	14.8	13.5	12	10.5	8.2	6		
-	F 50/125B	3	4		21.5	20.7	20	19.5	18.8	17.8	16.5	15	13.5	11.2	9		
-	F 50/125A	4	5.5		24.5	23.5	23	22.5	21.8	20.8	19.5	18.3	16.8	15	13		

Q = Flow rate H = Total manometric head HS = Suction height

Tolerance of characteristic curves in compliance with EN ISO 9906 Grade 3B.

## CHARACTERISTIC CURVES AND PERFORMANCE DATA

60 Hz n = 3450 min<sup>-1</sup> HS = 0 m

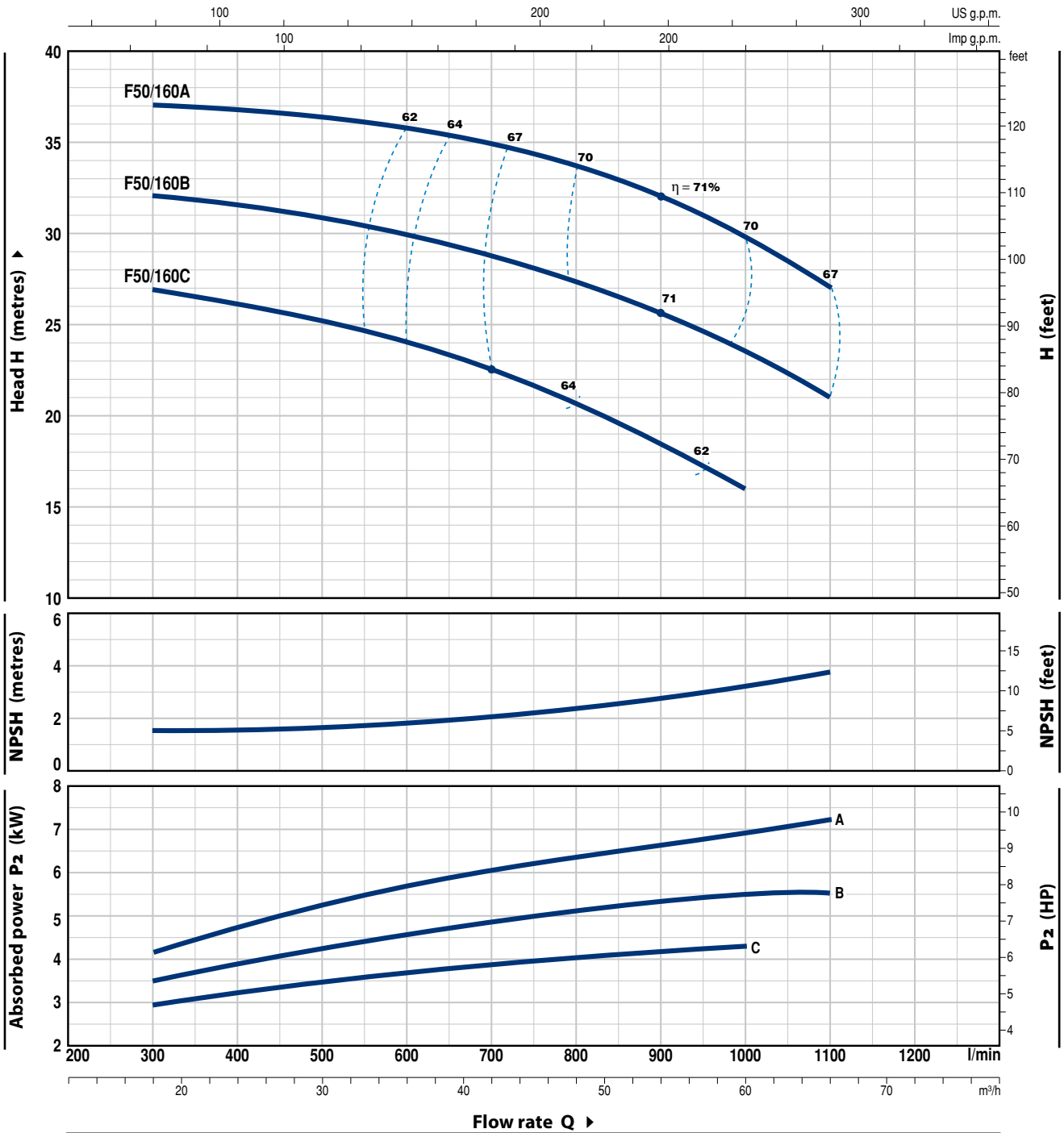

MODEL	POWER (P <sub>2</sub> )		Q	Flow rate											
	kW	HP		0	18	24	30	36	42	48	54	60	66		
Three-phase			l/min	0	300	400	500	600	700	800	900	1000	1100		
F 50/160C	4	5.5	H metres	27	27	26.5	25	24.5	23	20	18.5	16			
F 50/160B	5.5	7.5		33	32	31.7	31	30	29	27	26	24	21		
F 50/160A	7.5	10		38	37	36.8	36.5	36	34	33	32	30	27		

Q = Flow rate H = Total manometric head HS = Suction height

Tolerance of characteristic curves in compliance with EN ISO 9906 Grade 3B.

# F50/200

## CHARACTERISTIC CURVES AND PERFORMANCE DATA

60 Hz n = 3450 min<sup>-1</sup> HS = 0 m

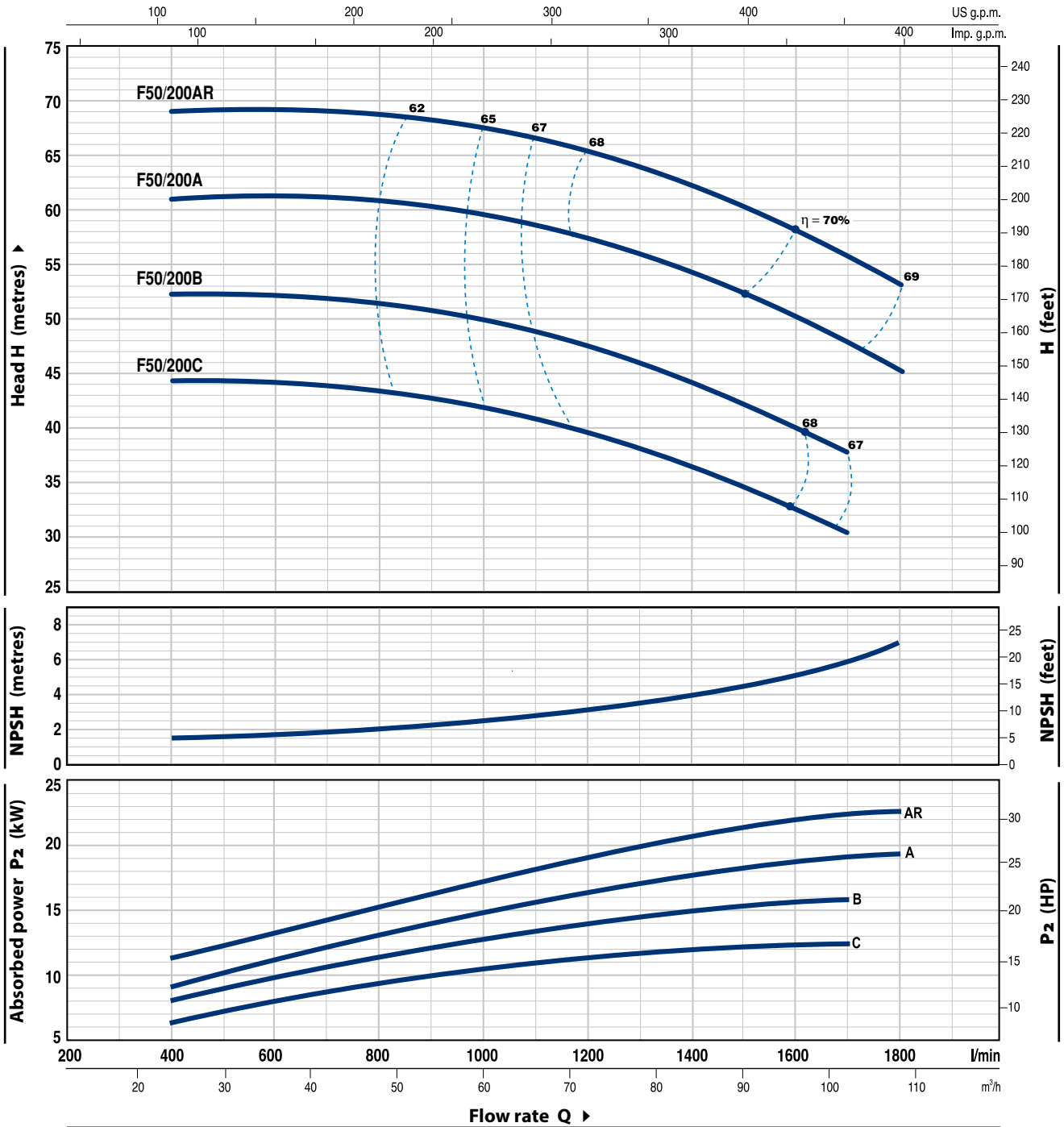

MODEL	POWER (P <sub>2</sub> )		Q	Flow rate Q										
	kW	HP		m <sup>3</sup> /h	24	36	48	60	72	84	96	102	108	
Three-phase			l/min	400	600	800	1000	1200	1400	1600	1700	1800		
F 50/200C	11	15	H metres	44	44	44	42	39	36	33	30			
F 50/200B	15	20		52	52	52	50	47	44	40	38			
F 50/200A	18.5	25		61	61	60.5	60	57	54	50	48	45		
F 50/200AR	22	30		69	69	68.5	68	65	62	58	56	53		

Q = Flow rate H = Total manometric head HS = Suction height

Tolerance of characteristic curves in compliance with EN ISO 9906 Grade 3B.

## CHARACTERISTIC CURVES AND PERFORMANCE DATA

60 Hz n = 3450 min<sup>-1</sup> HS = 0 m

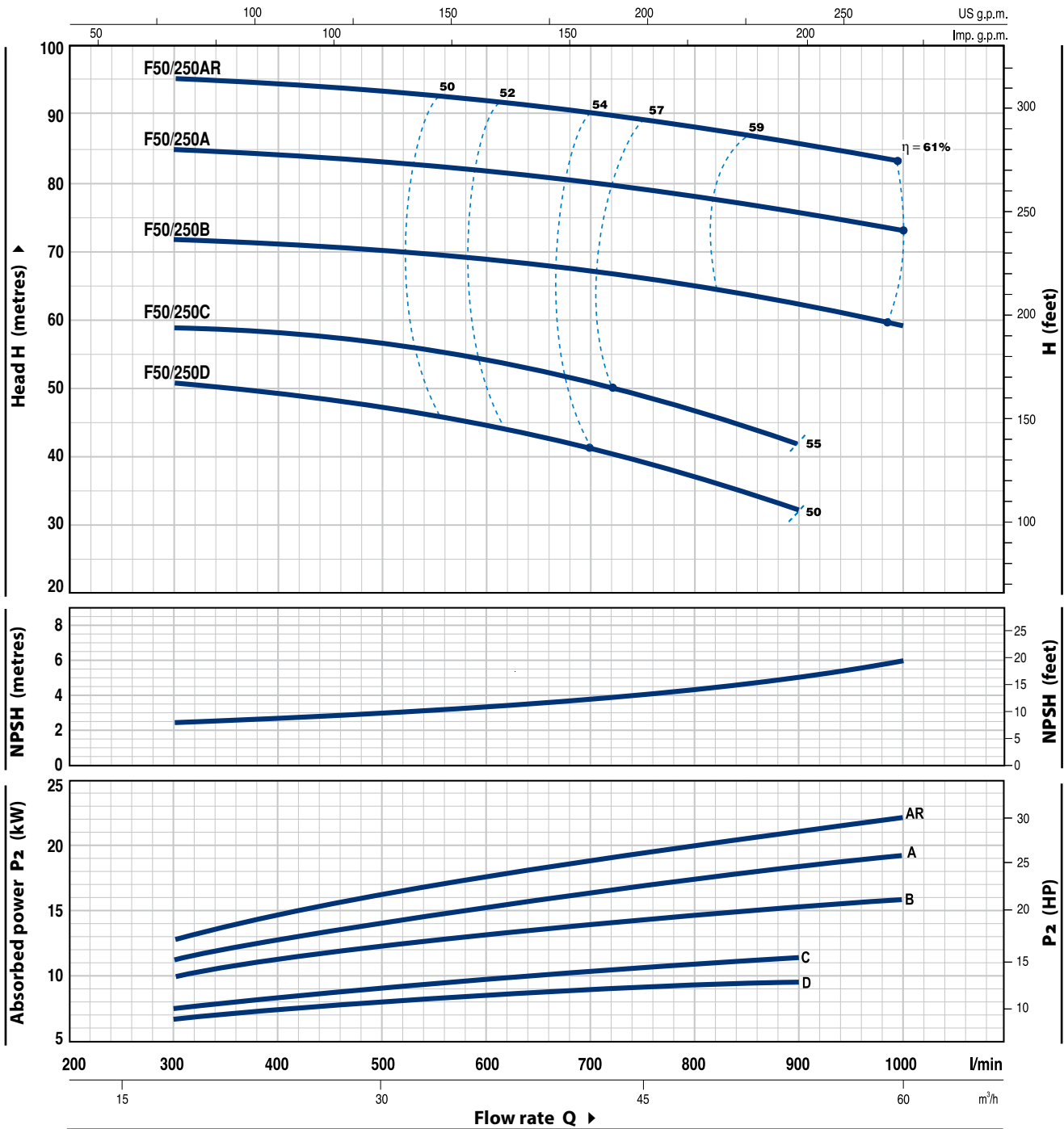

MODEL	POWER (P <sub>2</sub> )		Q	Flow rate										
	kW	HP		0	18	24	30	36	42	48	54	60		
Three-phase			l/min	0	300	400	500	600	700	800	900	1000		
F 50/250D	9.2	12.5	H metres	51	51	49	47	44	41	37	32			
F 50/250C	11	15		59	59	58	57	54	51	47	42			
F 50/250B	15	20		72	72	71	70	69	67	65	62	59		
F 50/250A	18.5	25		85	85	84	83	82	80	78	76	73		
F 50/250AR	22	30		95	95	94	93	92	90	88	86	83		

Q = Flow rate H = Total manometric head HS = Suction height

Tolerance of characteristic curves in compliance with EN ISO 9906 Grade 3B.

# F65/125

## CHARACTERISTIC CURVES AND PERFORMANCE DATA

60 Hz n = 3450 min<sup>-1</sup> HS = 0 m

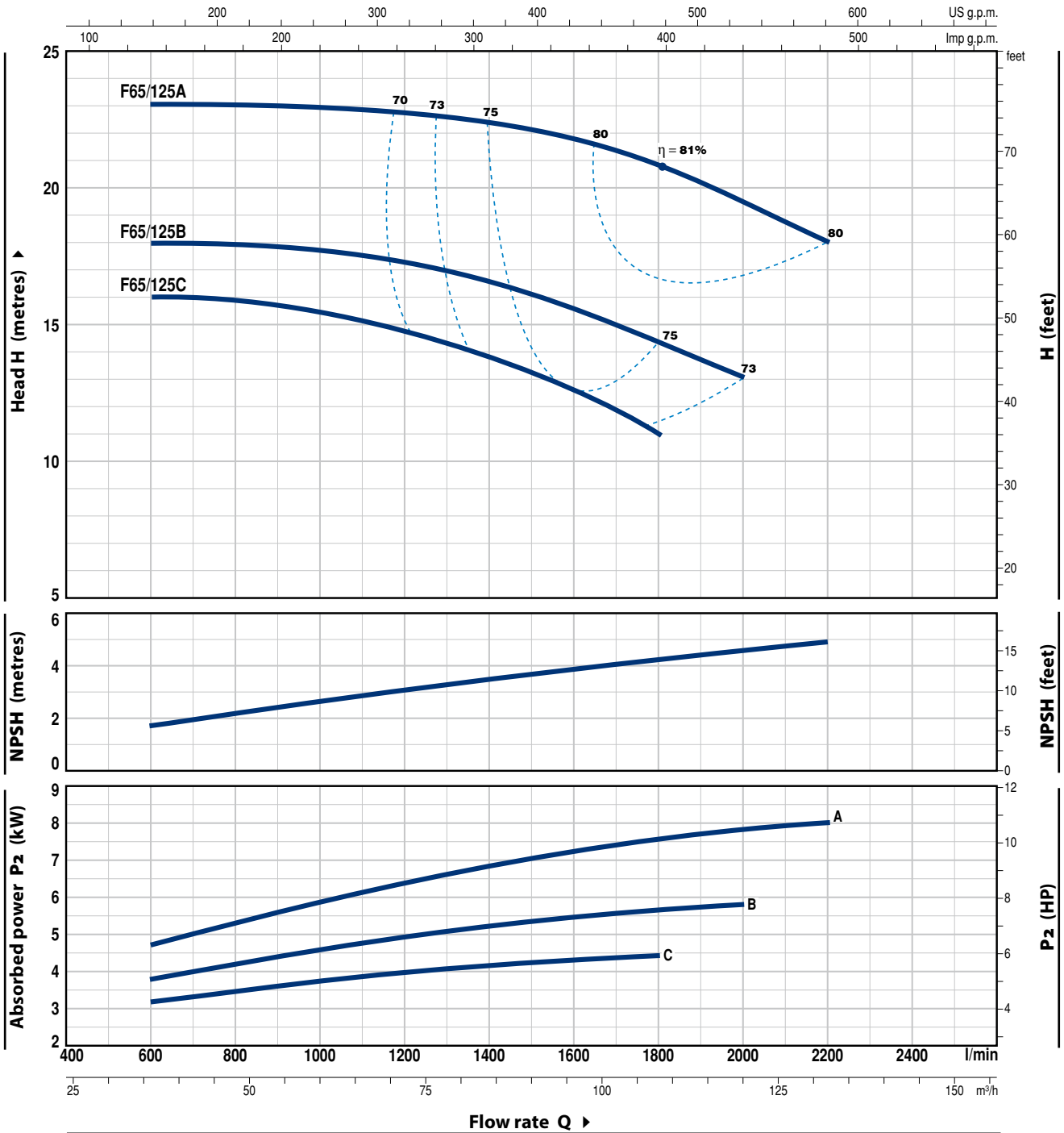

MODEL	POWER (P <sub>2</sub> )		Q	Flow rate											
	kW	HP		0	36	48	60	72	84	96	108	120	132		
Three-phase			l/min	0	600	800	1000	1200	1400	1600	1800	2000	2200		
F 65/125C	4	5.5	H metres	16	16	16	15.5	14.5	13.5	12.5	11				
F 65/125B	5.5	7.5		18	18	18	18	17	16.5	15.5	14.5	13			
F 65/125A	7.5	10		23	23	23	23	22.5	22.5	22	21	19.5	18		

Q = Flow rate H = Total manometric head HS = Suction height

Tolerance of characteristic curves in compliance with EN ISO 9906 Grade 3B.

## CHARACTERISTIC CURVES AND PERFORMANCE DATA

60 Hz n = 3450 min<sup>-1</sup> HS = 0 m

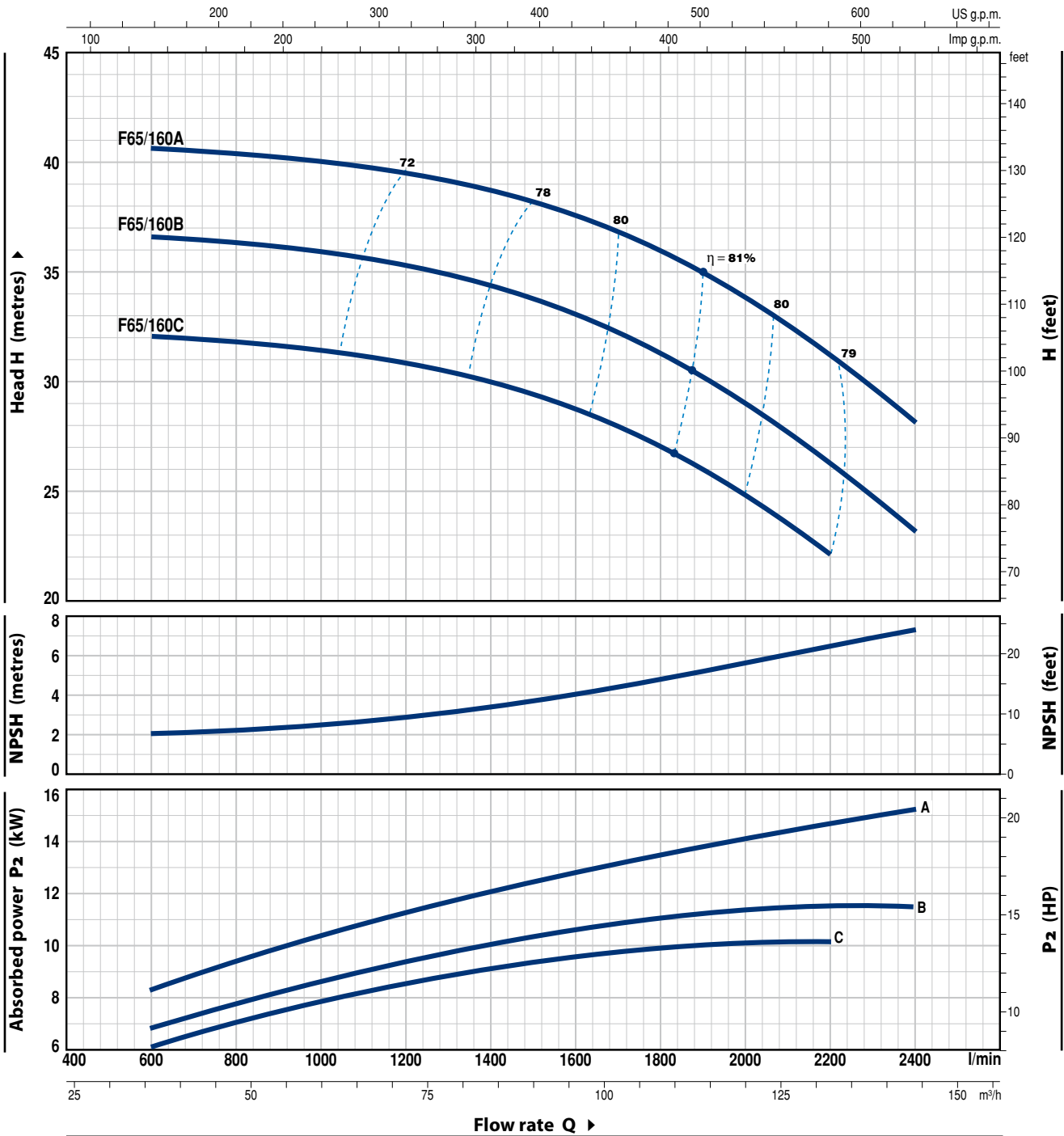

MODEL	POWER (P <sub>2</sub> )		Q	Flow rate												
	kW	HP		0	36	48	60	72	84	96	108	120	132	144		
Three-phase			l/min	0	600	800	1000	1200	1400	1600	1800	2000	2200	2400		
F 65/160C	9.2	12.5	H metres	32	32	32	32	32	30	29	27	25	22			
F 65/160B	11	15		37	36.5	36.5	36	35.5	34	33	31	29	26	23		
F 65/160A	15	20		41	40.5	40.5	40	39.5	39	37.5	36	34	31	28		

Q = Flow rate H = Total manometric head HS = Suction height

Tolerance of characteristic curves in compliance with EN ISO 9906 Grade 3B.



# F65/200

## CHARACTERISTIC CURVES AND PERFORMANCE DATA

60 Hz n = 3450 min<sup>-1</sup> HS = 0 m

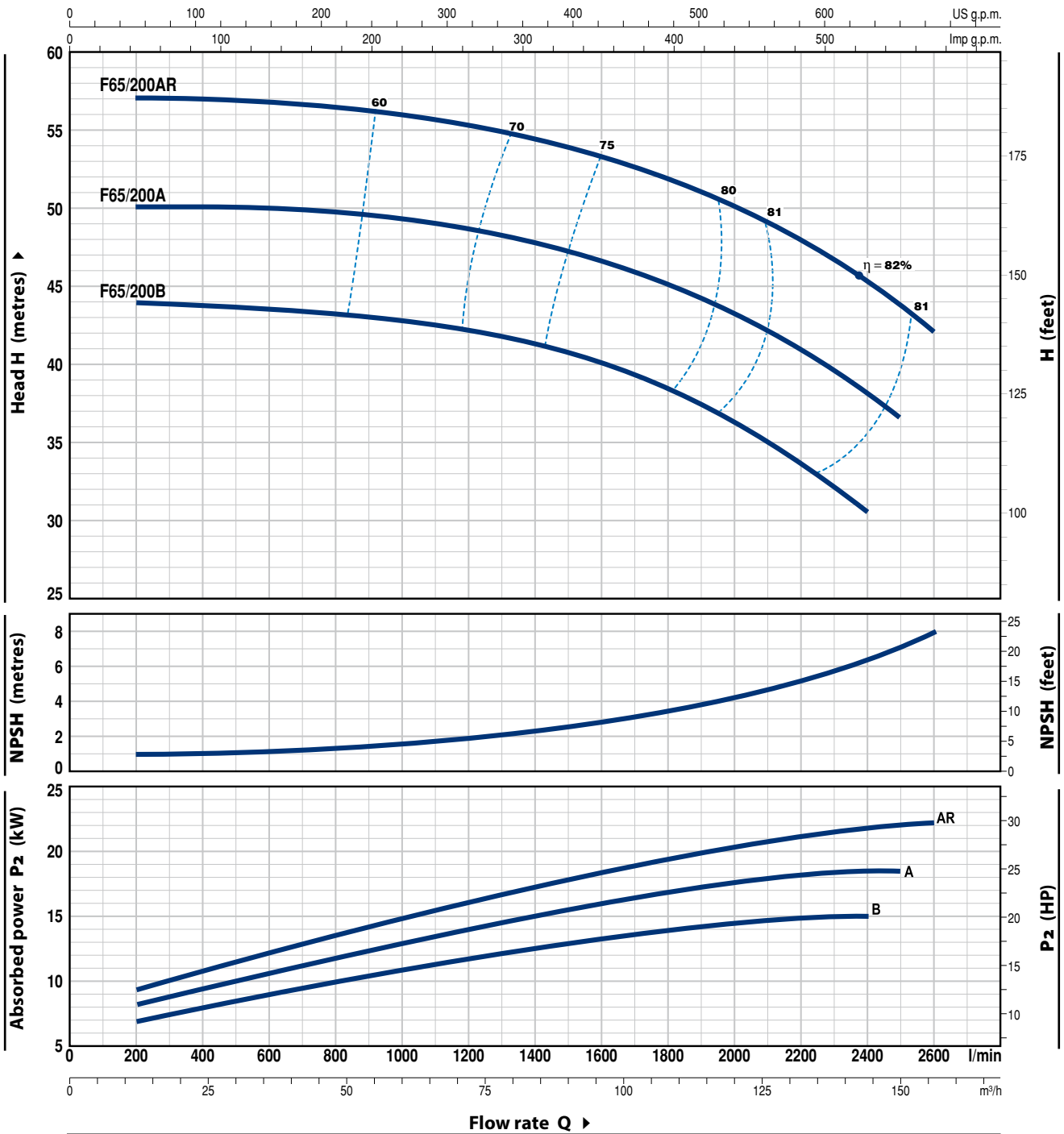

MODEL	POWER (P <sub>2</sub> )		Q	Flow rate														
	kW	HP		m <sup>3</sup> /h	12	36	48	60	72	84	96	108	120	132	144	150	156	
Three-phase			l/min	200	600	800	1000	1200	1400	1600	1800	2000	2200	2400	2500	2600		
F 65/200B	15	20	H metres	44	43.5	43.3	43	42.5	41.5	40	38.5	36.5	34	30.5				
F 65/200A	18.5	25		50	50	50	49.5	49	48	46.5	45	43	41	38	36.5			
F 65/200AR	22	30		57	57	57	56	55.5	54.5	53.5	52	50	48	45.5	43.5	42		

Q = Flow rate H = Total manometric head HS = Suction height

Tolerance of characteristic curves in compliance with EN ISO 9906 Grade 3B.

## CHARACTERISTIC CURVES AND PERFORMANCE DATA

60 Hz n = 3450 min<sup>-1</sup> HS = 0 m

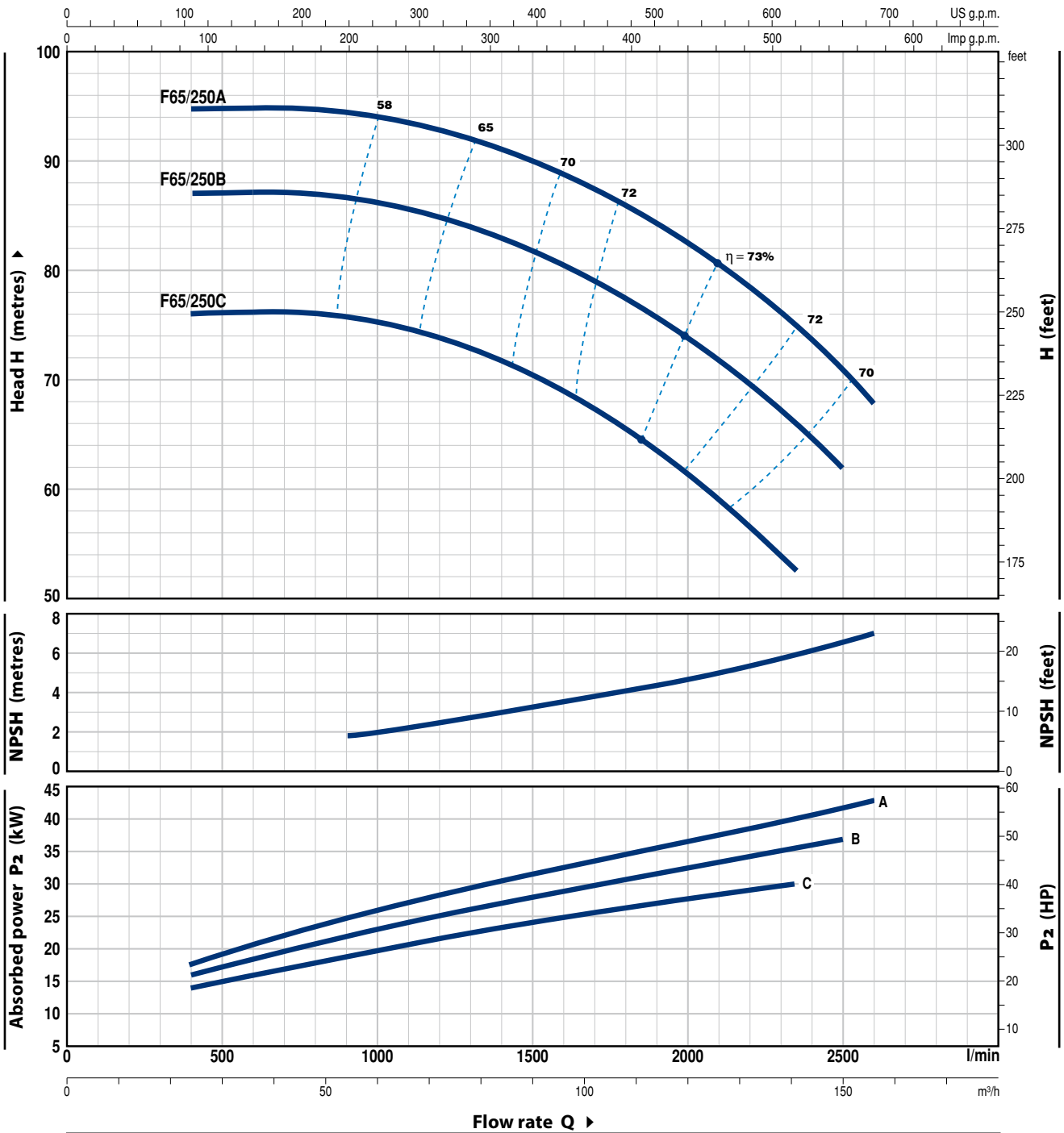

MODEL	POWER (P <sub>2</sub> )		Q	Flow rate											
	kW	HP		m <sup>3</sup> /h	24	40	60	80	100	120	141	150	156		
Three-phase			l/min	400	667	1000	1333	1667	2000	2350	2500	2600			
F 65/250C	30	40	H metres	76	76	75.5	72.5	68	61.5	53					
F 65/250B	37	50		87	87	86	84	80	74	66.5	62				
F 65/250A	45	60		95	95	94	92	88	82.5	75	71	68			

Q = Flow rate H = Total manometric head HS = Suction height

Tolerance of characteristic curves in compliance with EN ISO 9906 Grade 3B.

# F80/160

## CHARACTERISTIC CURVES AND PERFORMANCE DATA

60 Hz n = 3450 min<sup>-1</sup> HS = 0 m

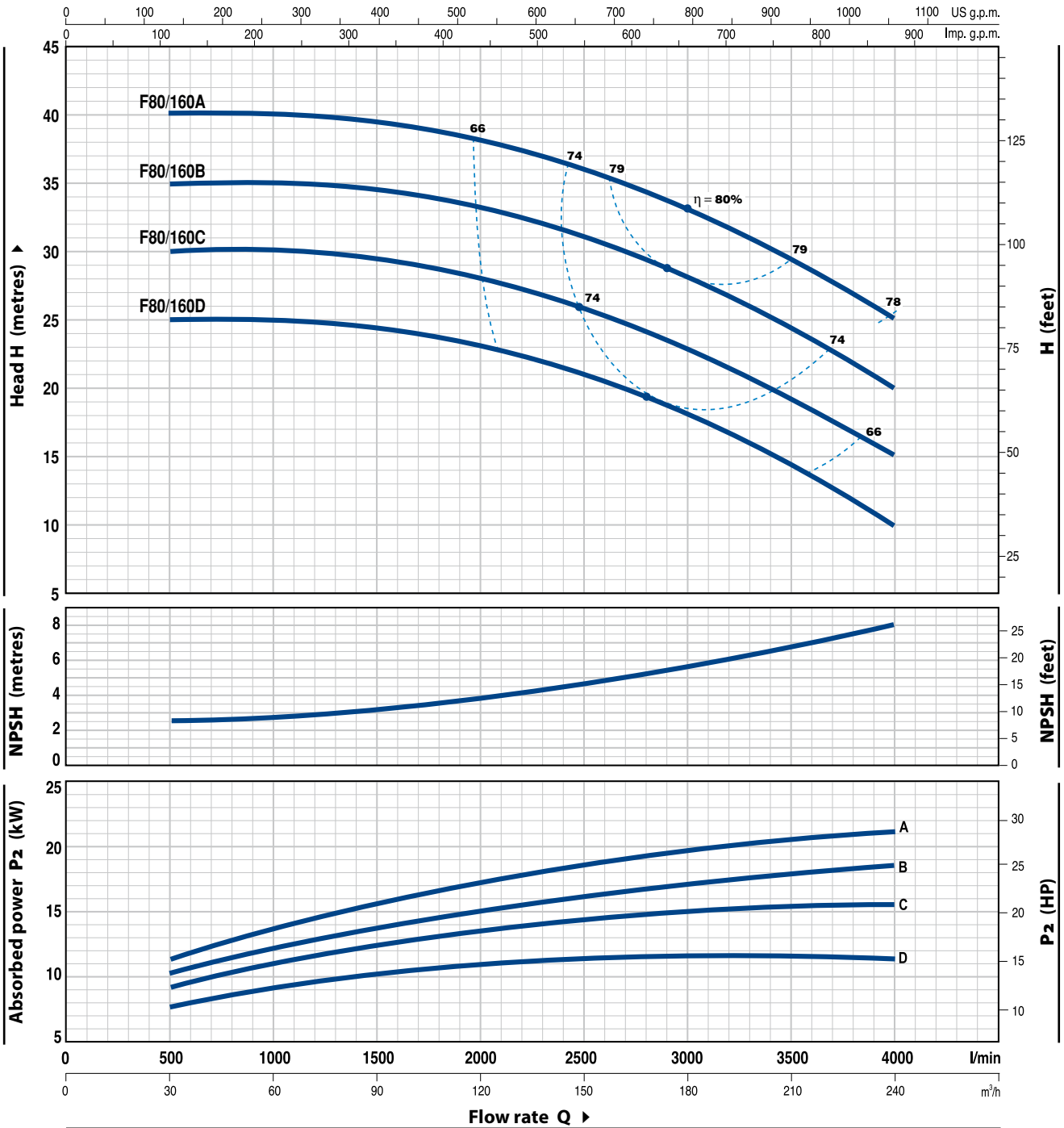

MODEL	POWER (P <sub>2</sub> )		Q	Flow rate Q										
	kW	HP		0	30	60	90	120	150	180	210	240		
Three-phase				0	500	1000	1500	2000	2500	3000	3500	4000		
F 80/160D	11	15	H metres	25	25	25	24.5	23.5	21	18	14.5	10		
F 80/160C	15	20		30	30	30	29.5	28.5	26	23	19.5	15		
F 80/160B	18.5	25		35	35	35	34.5	33.5	31	28.5	24.5	20		
F 80/160A	22	30		40	40	40	39.5	38.5	36	33	29.5	25		

Q = Flow rate H = Total manometric head HS = Suction height

Tolerance of characteristic curves in compliance with EN ISO 9906 Grade 3B.

## CHARACTERISTIC CURVES AND PERFORMANCE DATA

60 Hz n = 3450 min<sup>-1</sup> HS = 0 m

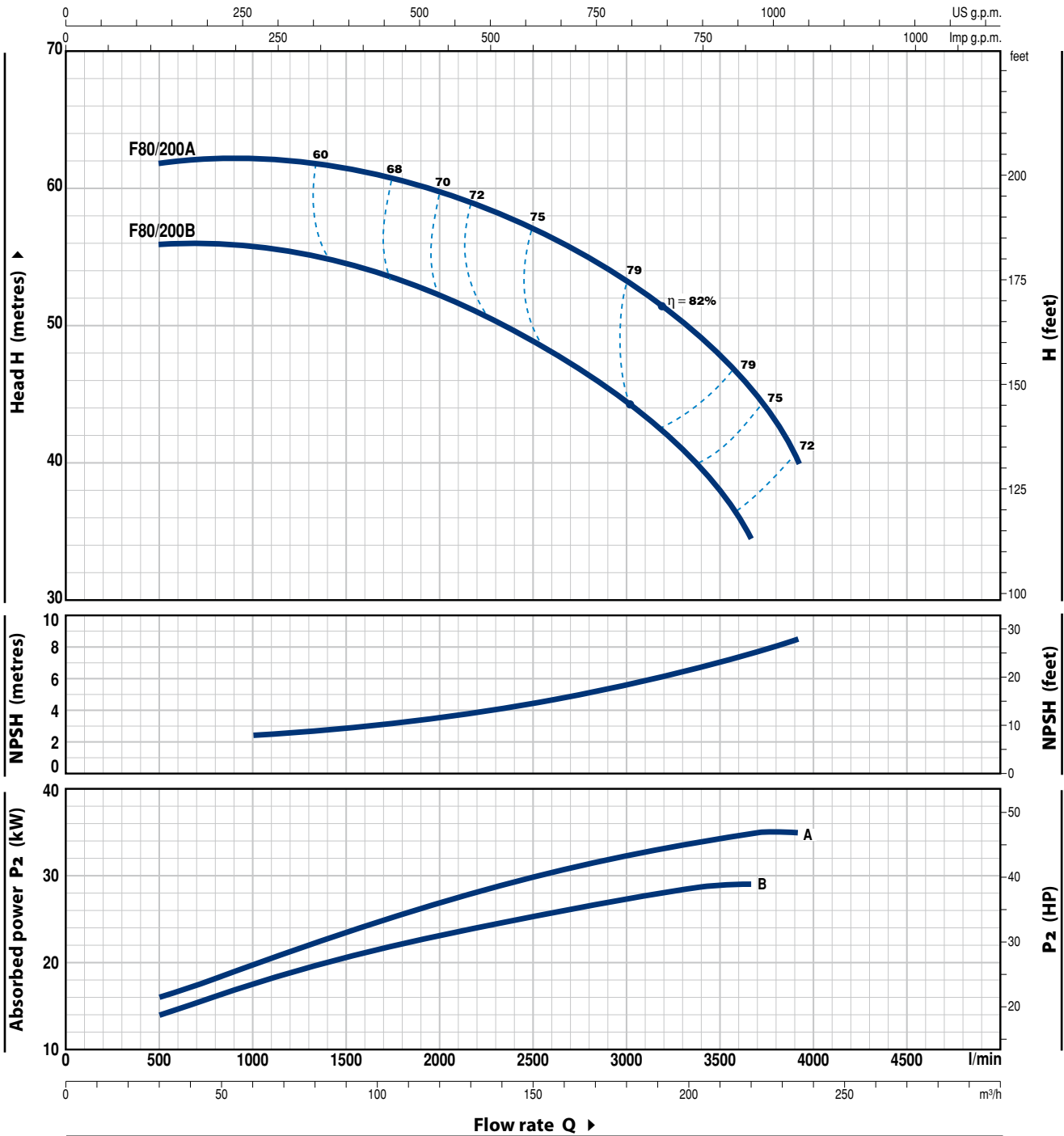

MODEL	POWER (P <sub>2</sub> )		Q	Flow rate								
	kW	HP		m <sup>3</sup> /h	l/min	30	50	100	150	200	219	234
Three-phase				500	833	1667	2500	3333	3650	3900		
F 80/200B	30	40	H metres	56	56	54	49	41	34.5			
F 80/200A	37	50		62	62	61	57	50	45.5	40		

Q = Flow rate H = Total manometric head HS = Suction height

Tolerance of characteristic curves in compliance with EN ISO 9906 Grade 3B.

# F80/250

## CHARACTERISTIC CURVES AND PERFORMANCE DATA

60 Hz n = 3450 min<sup>-1</sup> HS = 0 m

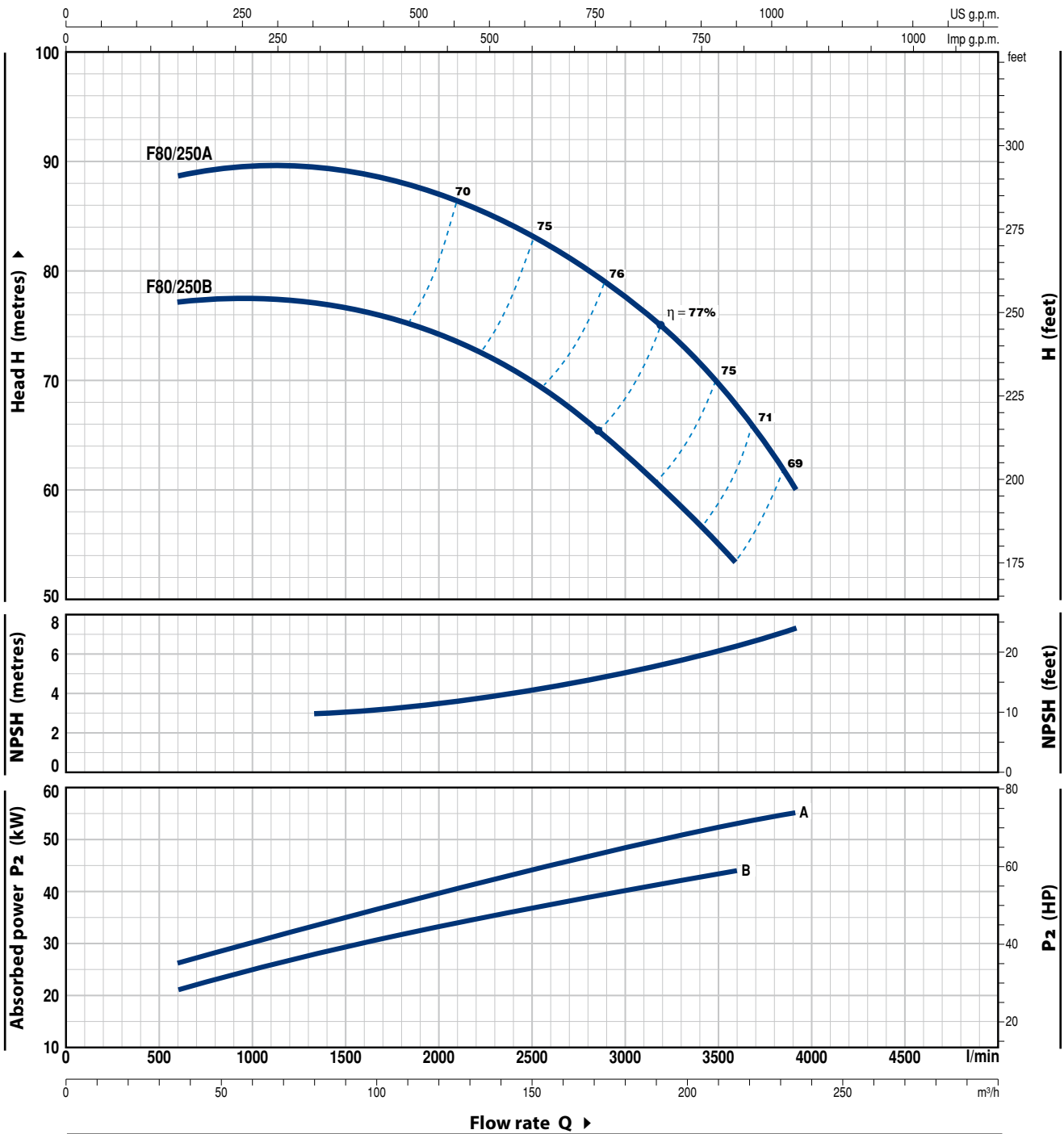

MODEL	POWER (P <sub>2</sub> )		Q	Flow rate							
	kW	HP		m <sup>3</sup> /h	l/min	l/min	l/min	l/min	l/min	l/min	l/min
Three-phase				36	50	100	150	200	216	234	
F 80/250B	45	60	H metres	77	77.5	76	70.5	58.5	54		
F 80/250A	55	75		88.5	89.5	89	83	72	68	60	

Q = Flow rate H = Total manometric head HS = Suction height

Tolerance of characteristic curves in compliance with EN ISO 9906 Grade 3B.

## CHARACTERISTIC CURVES AND PERFORMANCE DATA

60 Hz n= 3450 min<sup>-1</sup> HS= 0 m

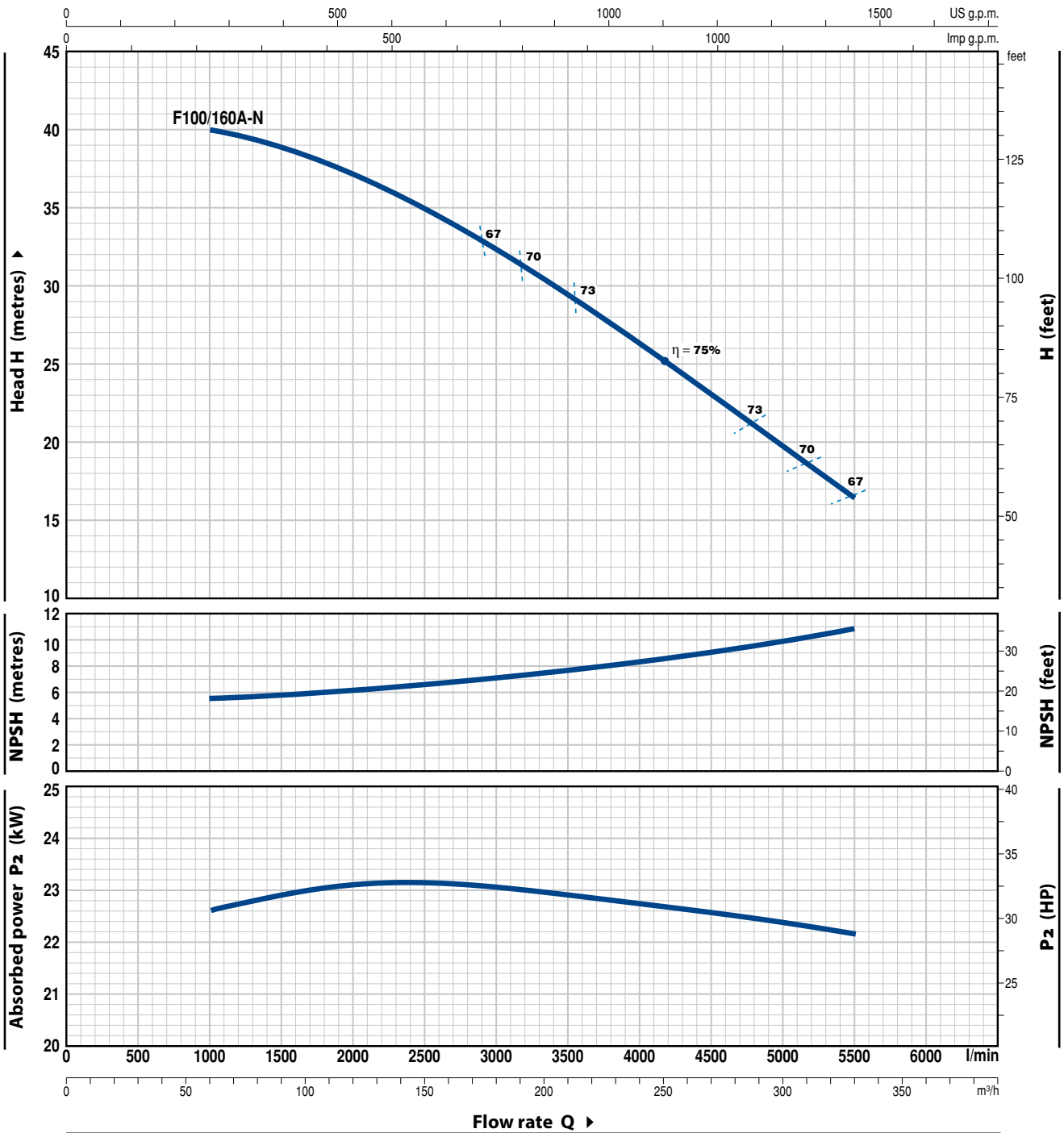

MODEL	POWER (P <sub>2</sub> )		Q	Flow rate										
	kW	HP		m <sup>3</sup> /h	0	60	120	180	240	270	300	330		
Three-phase			l/min	0	1000	2000	3000	4000	4500	5000	5500			
<b>F 100/160A-N</b>	22	30	H metres	40.5	40	37	32	26	23	19.5	16.5			

Q = Flow rate H = Total manometric head HS = Suction height

Tolerance of characteristic curves in compliance with EN ISO 9906 Grade 3B.

# F100/200

## CHARACTERISTIC CURVES AND PERFORMANCE DATA

60 Hz n = 3450 min<sup>-1</sup> HS = 0 m

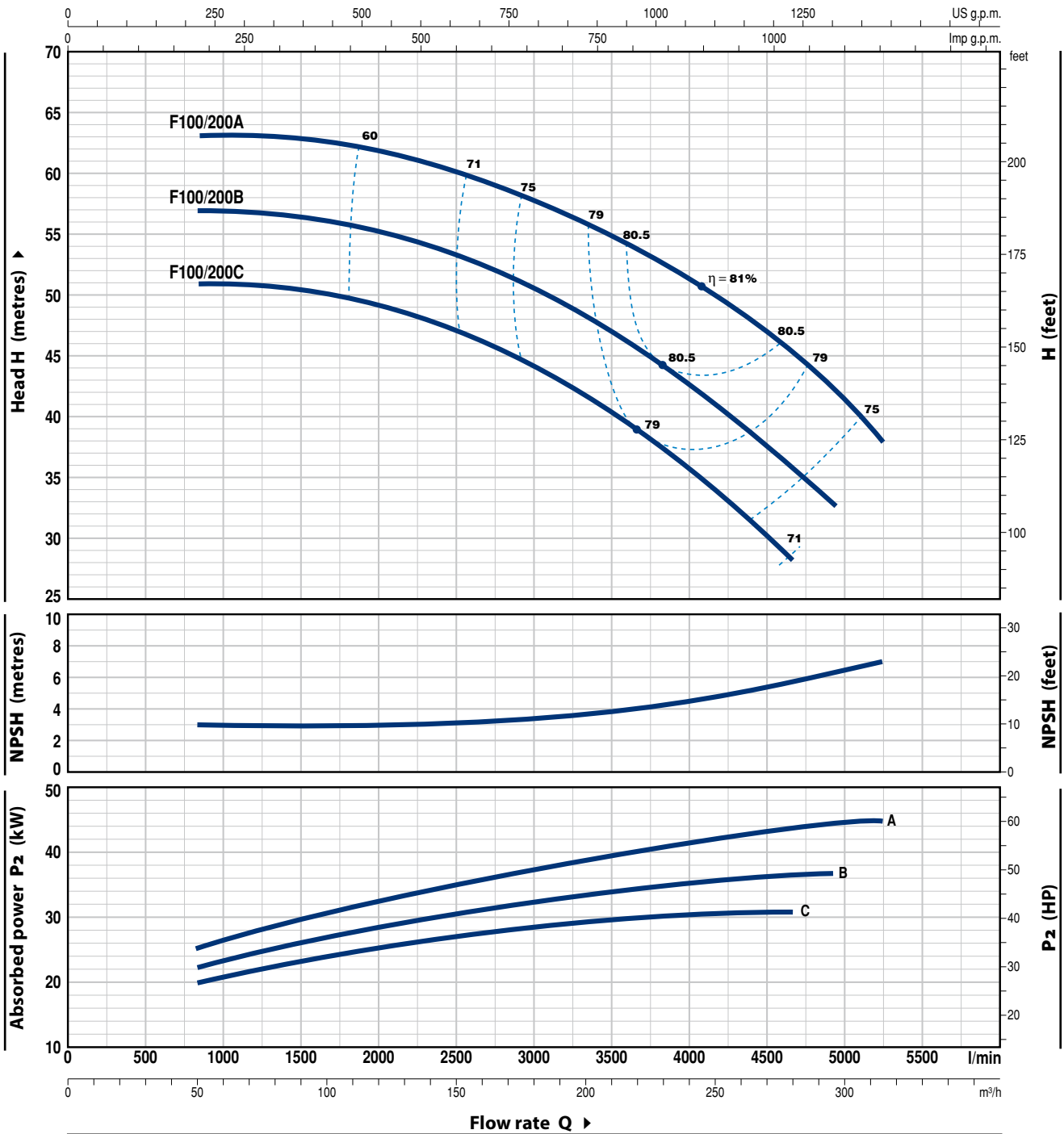

MODEL	POWER (P <sub>2</sub> )		Q	Flow rate Q											
	kW	HP		0	50	100	150	200	250	279	294	300	315		
Three-phase			l/min	0	833	1667	2500	3333	4167	4650	4900	5000	5250		
F 100/200C	30	40	H metres	51	51	50	47	41.5	34	28					
F 100/200B	37	50		57	57	56	53	48	41	36	33				
F 100/200A	45	60		63	63	62.5	60	56	50	45	42.5	41.5	38		

Q = Flow rate H = Total manometric head HS = Suction height

Tolerance of characteristic curves in compliance with EN ISO 9906 Grade 3B.

## CHARACTERISTIC CURVES AND PERFORMANCE DATA

60 Hz n = 3450 min<sup>-1</sup> HS = 0 m

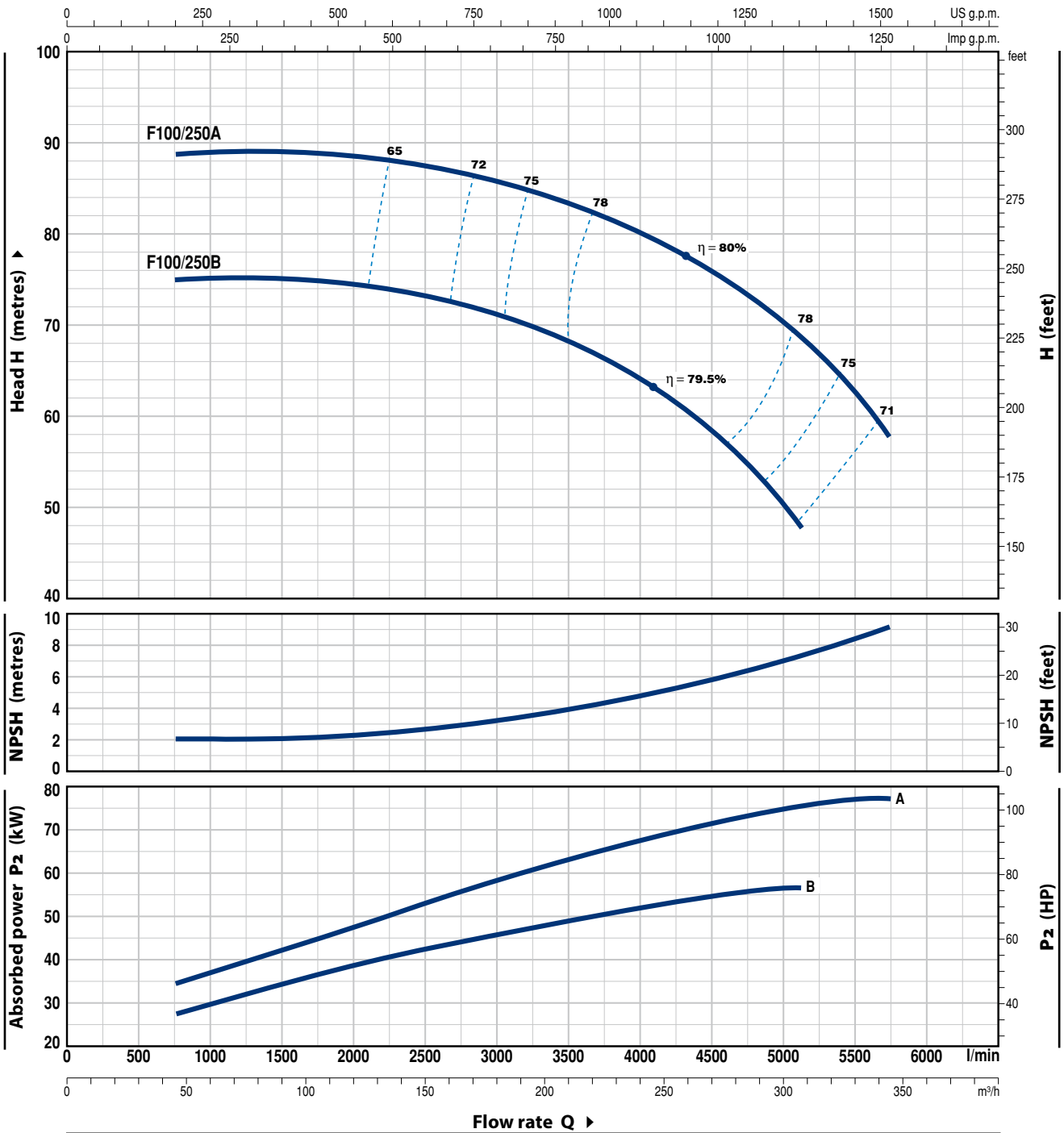

MODEL	POWER (P <sub>2</sub> )		Q	Flow rate										
	kW	HP		m <sup>3</sup> /h	48	96	150	180	210	240	300	309	345	
Three-phase			l/min	800	1600	2500	3000	3500	4000	5000	5150	5750		
F 100/250B	55	75	H metres	75	75	74	71.5	69	64.5	51	48			
F 100/250A	75	100		89	89	88.5	87	84	80.5	70.5	69	58		

Q = Flow rate H = Total manometric head HS = Suction height

Tolerance of characteristic curves in compliance with EN ISO 9906 Grade 3B.



## POS. COMPONENT CONSTRUCTION CHARACTERISTICS

<b>1 PUMP BODY</b>	Cast iron complete with flanged suction and delivery ports				
<b>2a BODY BACKPLATE</b>	Cast iron for F32/160, F32/200, F40/125, F40/160, F40/200, F50/125, F50/160, F65/125				
<b>2b MOTOR BRACKET</b>	Cast iron for F32/250, F40/250, F50/200, F50/250, F65/160, F65/200, F65/250, F80/160, F80/200, F80/250, F100/160, F100/200, F100/250				
<b>3 IMPELLER</b>	Brass for F32/160, F32/200, F40/125, F40/160, F40/200, F50/125, F50/160 Cast iron for F32/250, F40/250, F50/200, F50/250, F65/125, F65/160, F65/200, F65/250, F80/160, F80/200, F80/250, F100/160, F100/200, F100/250				
<b>4 MOTOR SHAFT</b>	Stainless steel AISI 431				
<b>5 MECHANICAL SEAL</b>	<b>Pump Model</b>	<b>Seal Model</b>	<b>Shaft Diameter</b>	<b>Stationary ring</b>	<b>Materials</b> Rotational ring    Elastomer
	F32/160, F40/125, F40/160, 50/125	<b>FN-20</b>	<b>Ø 20 mm</b>	Graphite	Ceramic    NBR
	F32/200, F40/200, F50/160, F65/125	<b>FN-24</b>	<b>Ø 24 mm</b>	Graphite	Ceramic    NBR
	F50/200, F65/160, F65/200, F80/160, F100/160	<b>FN-32 NU</b>	<b>Ø 32 mm</b>	Graphite	Ceramic    NBR
	F32/250, F40/250, F50/250	<b>FN-38</b>	<b>Ø 38 mm</b>	Graphite	Ceramic    NBR
	F65/250, F80/200, F80/250B, F100/200	<b>FN-40 NU</b>	<b>Ø 40 mm</b>	Graphite	Ceramic    NBR
	F80/250A, F100/250	<b>FH-45 NU</b>	<b>Ø 45 mm</b>	Graphite	Ceramic    NBR
<b>6 BEARINGS</b>	<b>Pump Model</b>	<b>Model</b>	<b>Pump Model</b>	<b>Model</b>	
	F32/160C    F40/160C	<b>6206 ZZ-C3 / 6204 ZZ</b>	F32/250    F50/200	<b>6310 ZZ-C3 / 6308 ZZ-C3</b>	
	F32/160B    F50/125C		F40/250    F65/160		
	F40/125		F50/250    F80/160		
	Fm32/160B    F32/160A	<b>6206 ZZ-C3 / 6205 ZZ</b>	F65/200    F100/160	<b>6312 ZZ-C3 / 6212 ZZ-C3</b>	
	Fm40/160C    F40/160B		F65/250    F80/200		
	Fm50/125C    F50/125B		F80/250B    F100/200		
	F40/160A	<b>6306 ZZ-C3 / 6206 ZZ-C3</b>	F80/250A	<b>6314 ZZ-C3 / 6313 ZZ-C3</b>	
	F50/125A		F100/250		
	F32/200    F40/200	<b>6307 ZZ-C3 / 6206 ZZ-C3</b>			
	F50/160    F65/125				
<b>7 CAPACITOR</b>	<b>Pump Single-phase</b>	<b>Capacitance (220 V)</b>			
	Fm32/160C	<b>45</b> µF - 450 VL			
	Fm32/160B	<b>70</b> µF - 450 VL			
	Fm40/125C	<b>31.5</b> µF - 450 VL			
	Fm40/125B	<b>45</b> µF - 450 VL			
	Fm40/125A	<b>50</b> µF - 450 VL			
	Fm40/160C	<b>70</b> µF - 450 VL			
	Fm50/125C	<b>70</b> µF - 450 VL			
<b>8 ELECTRIC MOTOR</b>	<b>Fm:</b> single-phase 220 V - 60 Hz with thermal overload protector incorporated into the winding (up to 1.5 kW) <b>F:</b> <b>three-phase 220/380 V - 60 Hz or 220/440 V - 60 Hz up to 22 kW</b> <b>380/660 V - 60 Hz between 30 and 75 kW</b> <b>► The three-phase pumps are fitted with high performance motors up to P<sub>2</sub>=1.1kW in class IE2 and from P<sub>2</sub>=1.5kW in class IE3 (IEC 60034-30)</b> – Insulation: class F    – Protection: IP 55				

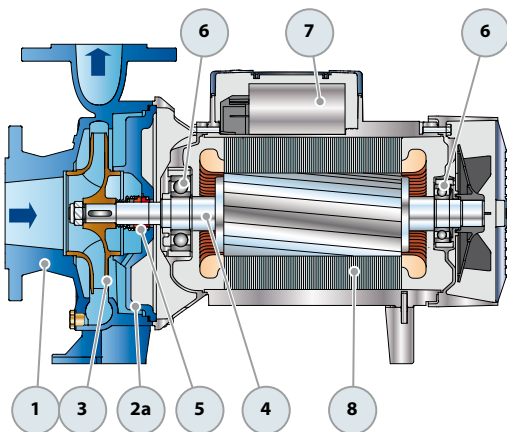

Single-phase version

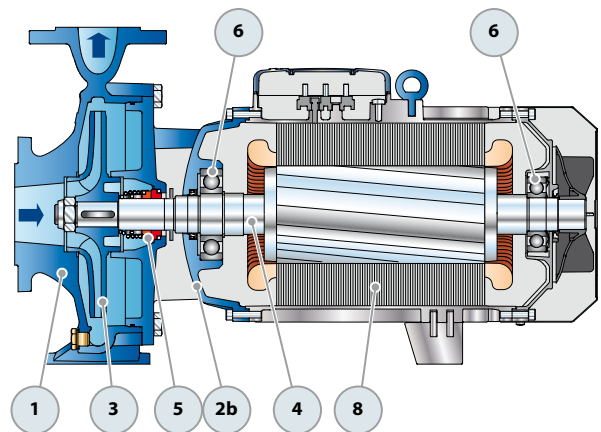

Three-phase version

## ABSORPTION

MODEL	VOLTAGE
Single-phase	220 V
Fm 32/160C	11.0 A
Fm 32/160B	15.0 A
Fm 40/125C	8.0 A
Fm 40/125B	11.0 A
Fm 40/125A	14.5 A
Fm 40/160C	17.0 A
Fm 50/125C	17.0 A

MODEL	VOLTAGE				
	220 V	380 V	660 V	220 V	440 V
Three-phase					
F 32/160C	7.8 A	4.5 A	2.6 A	8.0 A	4.5 A
F 32/160B	10.0 A	5.8 A	3.4 A	9.5 A	5.5 A
F 32/160A	12.1 A	7.0 A	4.0 A	12.1 A	6.5 A
F 32/200C	18.9 A	10.9 A	6.3 A	18.5 A	12.3 A
F 32/200B	24.0 A	13.9 A	8.0 A	22.0 A	13.8 A
F 32/200A	27.0 A	15.6 A	9.0 A	27.0 A	18.0 A
F 32/200BH	13.5 A	7.8 A	4.5 A	12.7 A	7.7 A
F 32/200AH	18.0 A	10.4 A	6.0 A	17.5 A	11.0 A
F 32/250C	38.0 A	22.0 A	12.7 A	39.8 A	20.0 A
F 32/250B	43.0 A	25.0 A	14.5 A	36.5 A	21.0 A
F 32/250A	57.0 A	33.0 A	19.1 A	60.0 A	34.0 A
F 40/125C	6.0 A	3.5 A	2.0 A	6.2 A	3.5 A
F 40/125B	7.8 A	4.5 A	2.6 A	8.0 A	4.5 A
F 40/125A	10.0 A	5.8 A	3.4 A	9.5 A	5.5 A
F 40/160C	10.0 A	5.8 A	3.4 A	8.7 A	5.0 A
F 40/160B	12.0 A	6.9 A	4.0 A	12.1 A	6.5 A
F 40/160A	20.9 A	12.1 A	7.0 A	19.5 A	12.5 A
F 40/200B	28.5 A	16.5 A	9.5 A	22.7 A	15.4 A
F 40/200A	30.9 A	17.8 A	10.3 A	28.5 A	21.8 A
F 40/250C	38.0 A	22.0 A	12.7 A	39.8 A	20.0 A
F 40/250B	43.0 A	25.0 A	14.5 A	36.5 A	21.0 A
F 40/250A	57.0 A	33.0 A	19.1 A	60.0 A	34.0 A
F 50/125C	10.7 A	6.2 A	3.6 A	9.8 A	6.7 A
F 50/125B	11.3 A	6.5 A	3.8 A	12.0 A	6.5 A
F 50/125A	18.2 A	10.5 A	6.1 A	19.0 A	12.5 A
F 50/160C	17.7 A	10.3 A	6.0 A	16.4 A	12.5 A
F 50/160B	21.0 A	12.0 A	6.9 A	20.8 A	13.5 A
F 50/160A	28.0 A	16.5 A	9.5 A	26.7 A	17.5 A
F 50/200C	46.0 A	26.5 A	15.3 A	47.0 A	25.0 A
F 50/200B	56.0 A	32.0 A	18.5 A	58.0 A	30.0 A
F 50/200A	67.5 A	39.0 A	22.5 A	70.0 A	36.0 A
F 50/200AR	87.0 A	51.0 A	29.5 A	78.0 A	45.0 A

MODEL	VOLTAGE				
	220 V	380 V	660 V	220 V	440 V
Three-phase					
F 50/250D	32.5 A	18.5 A	10.7 A	29.5 A	17.0 A
F 50/250C	44.0 A	25.0 A	14.5 A	36.5 A	21.0 A
F 50/250B	52.0 A	30.0 A	17.3 A	50.0 A	26.0 A
F 50/250A	64.0 A	37.0 A	21.4 A	66.0 A	36.0 A
F 50/250AR	82.0 A	48.0 A	27.7 A	83.0 A	47.0 A
F 65/125C	18.0 A	10.4 A	6.0 A	19.5 A	12.5 A
F 65/125B	22.5 A	13.0 A	7.5 A	22.0 A	13.8 A
F 65/125A	28.8 A	16.6 A	9.6 A	32.0 A	19.5 A
F 65/160C	37.0 A	21.5 A	12.4 A	37.0 A	24.0 A
F 65/160B	47.0 A	27.0 A	15.6 A	48.0 A	26.0 A
F 65/160A	55.0 A	32.0 A	18.5 A	59.0 A	33.0 A
F 65/200B	56.2 A	32.5 A	18.8 A	58.5 A	32.0 A
F 65/200A	73.5 A	42.5 A	24.5 A	70.0 A	36.0 A
F 65/200AR	97.0 A	56.0 A	32.3 A	79.0 A	48.0 A
F 65/250C	-	64.0 A	37.0 A	-	-
F 65/250B	-	70.0 A	40.4 A	-	-
F 65/250A	-	88.0 A	50.8 A	-	-
F 80/160D	45.0 A	26.0 A	15.0 A	50.0 A	27.0 A
F 80/160C	59.0 A	34.0 A	19.7 A	60.0 A	30.0 A
F 80/160B	66.0 A	38.0 A	22.0 A	70.0 A	36.0 A
F 80/160A	93.5 A	54.0 A	31.2 A	79.0 A	48.0 A
F 80/200B	-	61.0 A	35.0 A	-	-
F 80/200A	-	70.0 A	40.5 A	-	-
F 80/250B	-	88.0 A	51.0 A	-	-
F 80/250A	-	112.0 A	65.0 A	-	-
F 100/160A-N	81.5 A	47.0 A	27.2 A	76.0 A	43.0 A
F 100/200C	-	64.0 A	37.0 A	-	-
F 100/200B	-	70.0 A	40.4 A	-	-
F 100/200A	-	88.0 A	50.8 A	-	-
F 100/250B	-	94.0 A	54.3 A	-	-
F 100/250A	-	132.0 A	76.2 A	-	-

## DIMENSIONS AND WEIGHT

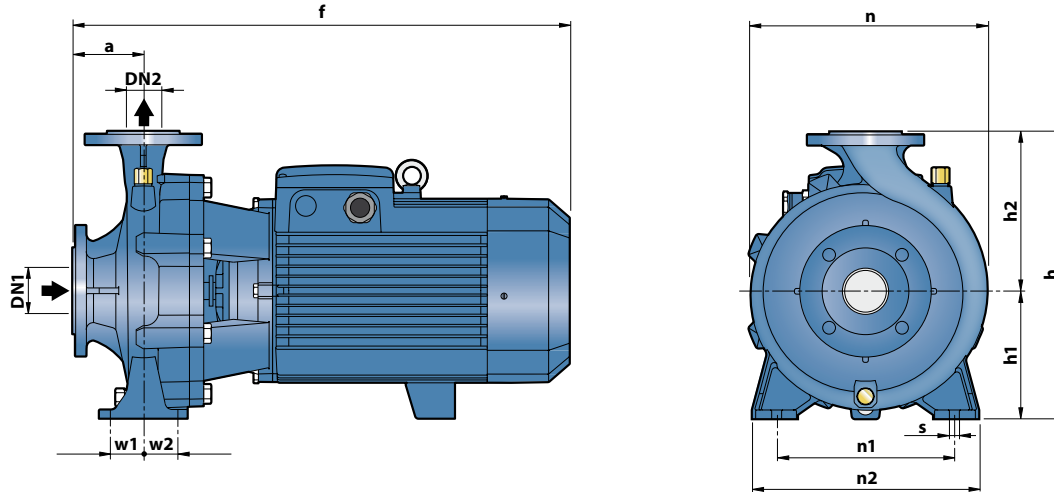

MODEL		DIMENSIONS mm													kg									
Single-phase	Three-phase	DN1	DN2	a	f	h	h1	h2	n	n1	n2	w1	w2	s	1~	3~								
Fm 32/160C	F 32/160C	50	32	80	412	340	160	180	270	190	240	35	35	14	32.7	32.1								
Fm 32/160B	F 32/160B				448/412										292	132	160	242	37.5	33.4				
-	F 32/160A				448										-	-	-	-	-	-				
-	F 32/200C				469										-	-	-	-	-	-				
-	F 32/200B				515										-	-	-	-	-	-				
-	F 32/200A			100	701	405	405	180	225	330	250	320	47.5		47.5	-	46.4							
-	F 32/200BH															469	-	-	-	-	-	-		
-	F 32/200AH															-	-	-	-	-	-	-		
-	F 32/250C															606	-	-	-	-	-	-		
-	F 32/250B															701	-	-	-	-	-	-		
-	F 32/250A	65	40	80	421	340	160	180	275	212	265	35	35	31.5	29.5									
Fm 40/125C	F 40/125C				451/421									252	112	140	244	160	210	33.0	31.5			
Fm 40/125B	F 40/125B				448/412									292	132	160	240	190	240	35.5	33.0			
Fm 40/125A	F 40/125A				448									-	-	-	-	-	-	37.6	33.5			
Fm 40/160C	F 40/160C				465									-	-	-	-	-	-	-	37.5			
-	F 40/160B			100	701	405	405	180	225	328	250	320	47.5	47.5	-	43.6								
-	F 40/160A														535	-	-	-	-	-	-			
-	F 40/200B														606	-	-	-	-	-	-			
-	F 40/200A														701	-	-	-	-	-	-			
-	F 40/250C														606	-	-	-	-	-	-			
-	F 40/250B	65	50	100	465/431	340	160	180	269	212	265	35	35	37.3	33.2									
-	F 50/125C				465									292	132	160	242	190	240	-	37.2			
-	F 50/125B				484									-	-	-	-	-	-	-	43.3			
-	F 50/125A				489									-	-	-	-	-	-	-	48.0			
-	F 50/160C				535									340	-	-	-	-	-	-	52.5			
-	F 50/160B			125	711	360	360	160	200	316	212	265	47.5	47.5	-	56.4								
-	F 50/160A														616	-	-	-	-	-	-			
-	F 50/200C														711	-	-	-	-	-	-			
-	F 50/200B														743	-	-	-	-	-	-			
-	F 50/200A														606	-	-	-	-	-	-			
-	F 50/200AR	125	733	405	405	180	225	337	250	320	47.5	47.5	-	101.3										
-	F 50/250D												606	-	-	-	-	-	-					
-	F 50/250C												701	-	-	-	-	-	-					
-	F 50/250B												733	-	-	-	-	-	-					
-	F 50/250A												733	-	-	-	-	-	-					
-	F 50/250AR	80	65	125	511	340	160	180	291	212	280	47.5	47.5	-	53.5									
-	F 65/125C				557									340	-	-	-	-	-					
-	F 65/125B				621									360	-	-	-	-	-					
-	F 65/125A				716									-	-	-	-	-	-					
-	F 65/160C				719									-	-	-	-	-	-					
-	F 65/160B			125	751	405	405	180	225	340	250	320	47.5	47.5	-	63.3								
-	F 65/160A														621	360	200	300	212	280	47.5	47.5	-	98.3
-	F 65/200B														716	-	-	-	-	-	-			
-	F 65/200A														719	-	-	-	-	-	-			
-	F 65/200AR														751	-	-	-	-	-	-			
-	F 80/160D	100	80	125	652	405	180	225	250	320	250	320	60	60	-	144.4								
-	F 80/160C				747										-	-	-	-	-	-				
-	F 80/160B				779										-	-	-	-	-	-				
-	F 80/160A				790										-	-	-	-	-	-				
-	F 100/160A-N				790										480	200	280	362	280	360	60	60	18	-

## DIMENSIONS AND WEIGHT

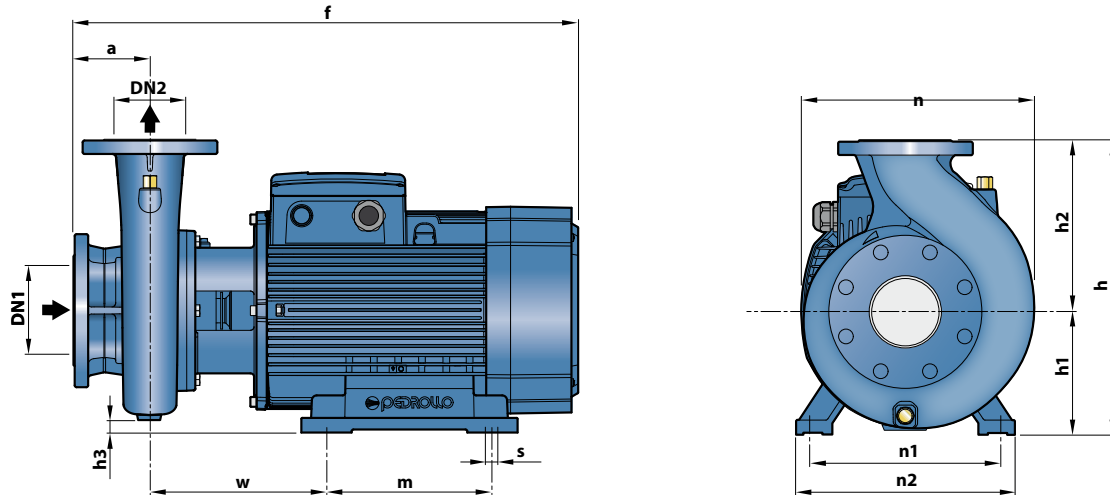

MODEL	DIMENSIONS mm														kg 3~
	DN1	DN2	a	f	h	h1	h2	h3	n	n1	n2	w	m	s	
<b>Three-phase</b>															
<b>F 65/250C</b>	80	65	100	796	450	200	250	15	369	318	360	269.5	305	18.5	<b>201.3</b>
<b>F 65/250B</b>				847											<b>201.3</b>
<b>F 65/250A</b>				847											<b>219.3</b>
<b>F 80/200B</b>	100	80	125	824	430	280	280	25	360	400	490	294	350	24	<b>201.6</b>
<b>F 80/200A</b>				875											<b>201.6</b>
<b>F 80/250B</b>				872											<b>234.5</b>
<b>F 80/250A</b>				1015	620	250	280	55	490	400	490	294	350	24	<b>539.0</b>
<b>F 100/200C</b>	125	100	140	824	480	200	280	0	391	318	360	269.5	305	18.5	<b>225.3</b>
<b>F 100/200B</b>				875											<b>225.3</b>
<b>F 100/200A</b>				875											<b>233.3</b>
<b>F 100/250B</b>				1036	620	250	280	45	490	400	490	300	350	24	<b>539.3</b>
<b>F 100/250A</b>															<b>539.3</b>

## FLANGED PORTS

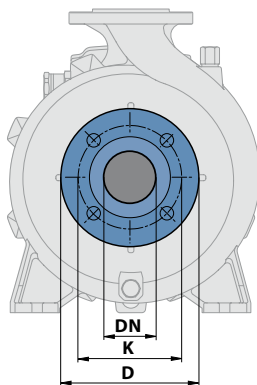

## COUNTERFLANGES

(CAN BE ORDERED SEPARATELY)

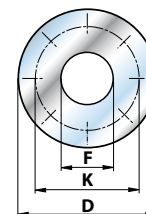

DN FLANGES mm	D mm	K mm	HOLES	
			N.	Ø (mm)
32	140	100	4	18
40	150	110		
50	165	125		
65	185	145		
80	200	160		
100	220	180	8	
125	250	210		

DN FLANGES mm	F COUNTERFLANGES	D mm	K mm	HOLES	
				N.	Ø (mm)
32	1¼"	140	100	4	18
40	1½"	150	110		
50	2"	165	125		
65	2½"	185	145		
80	3"	200	160		
100	4"	220	180	8	
125	5"	250	210		